

Table of Contents

Table of Contents Page 1
 Approvals Page 1
 Attention Page 1
 Specification Page 2
 Model Description & Part Number Page 2
 Mounting Page 3
 Wiring Page 3
 Operation Page 4
 Operation & Adjustment Page 4
 Installation Position Page 4
 Maintenance & Testing Page 5
 Mounting to Safety Valves Page 6
 Mounting to Safety Valves or FRI Regulator .. Page 7
 Accessories & Replacement Page 8



Approvals

-  UL Listed: UL 353
File # MH16628
-  CSA Certified: CSA C22.2 No. 14
File # 201527
-  FM Approved: Class 3510, 3530
File # J.I. 1Y9A9.AF

Commonwealth of Massachusetts Approved Product Approval code G3-0106-191

Attention



The installation and maintenance of this product must be done under the supervision of an experienced and trained specialist. Never perform work if gas pressure or power is applied, or in the presence of an open flame.



Check the ratings in the specifications to verify that they are suitable for your application.



Please read the instruction before installing or operating. Keep the instruction in a safe place. You find the instruction also at www.dungs.com. If these instructions are not heeded, the result may be personal injury or damage to property.



On completion of work on the pressure switch, perform a leakage and function test.



Any adjustment and application-specific adjustment values must be made in accordance with the equipment manufacturers instructions.



This product is intended for installations covered by, but not limited to, the following codes and standards: NFPA 86, ANSI Z83.4/CSA 3.7, ANSI Z83.18/CSA 4.9, ANSI Z21.13, CSD-1, UL 795, CSA B149.1 or CSA B149.3

Explanation of symbols

- 1, 2, 3 ... = Action
- = Instruction

Specification

GAO-A2, GMH-A2, GML-A2 High/low ventless gas pressure switch (SPDT) with automatic or manual reset. Includes visual indication of switch position. Mounts directly to various ports on the SV, DMV and MB series valves and FRI series regulators.



Max. Operating Pressure
MOP = 7 PSI (500 mbar)

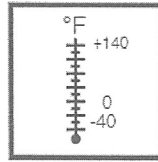

Ambient / Fluid Temperature

Versions
-2, -3, -4, -5 & -6: -40 °F to +140 °F;
(-40 °C to +60 °C)
Versions
-8: -20 °F to +140 °F;
(-30 °C to +60 °C)



Electrical Connection
Screw terminals via 1/2" NPT conduit connection

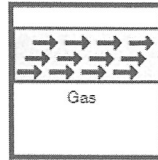

Gases

Dry, natural gas, propane, butane; other noncorrosive gases. Suitable for up to 0.1% by volume, dry H₂S. A "dry" gas has a dew point lower than +15 °F and its relative humidity is less than 60%.

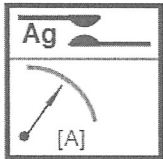

Contact Rating
10 A resistive @ 120 VAC
3 A inductive @ 120 VAC
1 A @ 12 - 48 VDC

Materials in contact with Gas

Housing: Aluminum & Steel
Diaphragm: NBR-based rubber

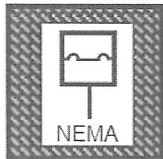

Enclosure
NEMA Type 4

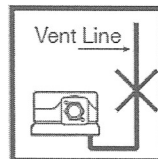

Vent Limiter

Incorporates a vent limiter as per UL 353 and limits the escape of gas less than 1.0 CFH of natural gas at 7 PSI if internal switch diaphragm rupture. No vent line required, when accepted by the authority having jurisdiction.

Model Description & Part Number

Type	Version	Order No.	Setting range in. W.C.	Switching hysteresis in. W.C.	Factory Calibration
GAO-A2-... pressure switch	GAO-A2-4-2	217-085A	0.16 - 1.20	≤ 0.12	↑
	GAO-A2-4-3	217-086A	0.40 - 4.00	≤ 0.20	
	GAO-A2-4-5	217-087A	2.00 - 20.00	≤ 0.40	
	GAO-A2-4-6	217-088A	12.00 - 60.00	≤ 1.2	
	GAO-A2-4-8	217-089A	40.00 - 200.00	≤ 4.0	
GMH-A2-... pressure switch	GMH-A2-4-4	217-323A	1.00 - 20.00	--	↑
	GMH-A2-4-6	217-324A	12.00 - 60.00	--	
	GMH-A2-4-8	217-325A	40.00 - 200.00	--	
GML-A2-... pressure switch	GML-A2-4-4	217-337A	1.00 - 20.00	--	↓
	GML-A2-4-6	217-338A	12.00 - 60.00	--	
	GML-A2-4-8	217-339A	40.00 - 200.00	--	

Mounting

Recommended Mounting Procedure

1. Remove the clear cover ❶ of the switch in order to remove the thread forming socket head screws.
2. Verify that the O-ring ❷ and the groove, in which the O-ring is placed, are clean and free of notches or burrs.
3. Place the O-ring into the groove on the back of the pressure switch. This is located on the flange side of the aluminum housing.
4. Using a 3 mm hex wrench, remove the G 1/8 plug from the port on which the switch is to be mounted. This will be either a flange, the side of the FRI regulator, or a G1/8 port of Dungs safety shutoff valve.
5. Mount the switch onto the port using the thread-forming socket head screws ❸.
6. The O-ring ❷ can slide during the mounting process, so it is recommended that as the switch is pressed onto the port, visually verify that the O-ring remains in the groove.
7. Tighten the screws ❸ but do not exceed 22 lb-in. Perform a leak test to verify that no leakage occurs around the o-ring.

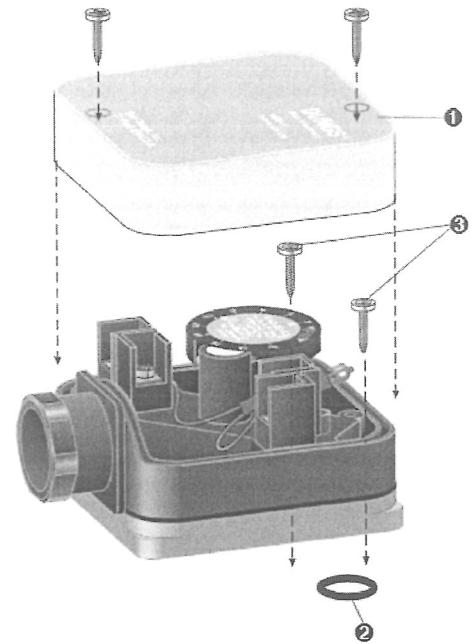

Wiring

Wiring Procedure

1. Remove the clear cover from the switch.
2. Use 14 or 16 AWG wire rated for at least 75 °C
3. Route the wires through the conduit connector.
4. Install a conduit plug at some point in the conduit run between the switch and closest panel that contains switching contacts or other sparking devices (see NFPA 86 requirements about potential risks of gas leaking down conduit).
5. Connect the wiring to the appropriate screw terminals.

Wiring terminal illustration

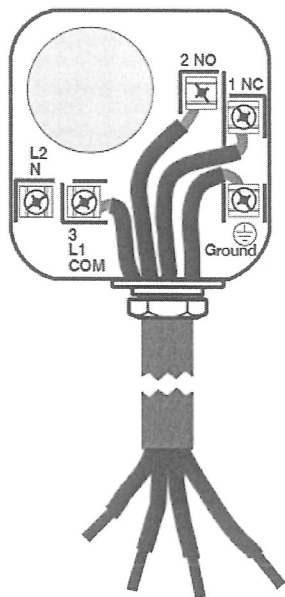

GMH High Gas Switch (Operating state shown) As pressure rises above setpoint, 2 NO closes, 1 NC opens, and Neon light ON (fault), switch trips and locks out.

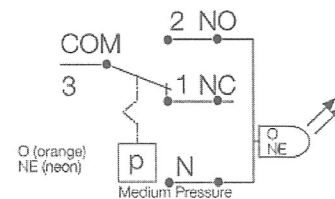

GAO Low or High Gas Switch (Operating state shown as a high limit). As pressure rises above set point, 1 NC opens, 2 NO closes, Neon light ON. As pressure falls below set point, switch resets: 1 NC closes and 2 NO opens, Neon light off.

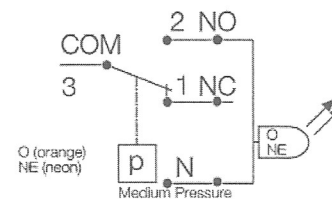

GML Low Gas Switch (Operating state shown)

As pressure falls below setpoint, 2 NO opens, 1 NC closes, Neon light ON (fault), switch trips and locks out.

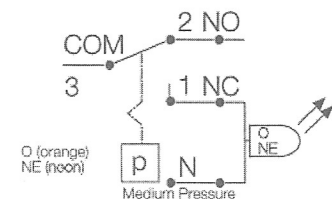

⚠ All wiring must comply with local electrical codes, ordinances and regulations.

⚠ Do not exceed the switch ratings given in the specifications and on the switch

Operation

Definition of switching hysteresis Δp

The pressure difference between the upper and lower switching pressures.

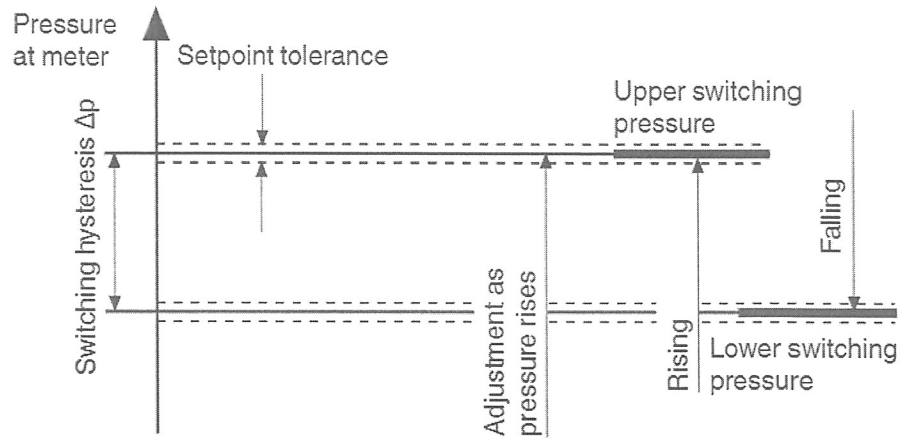

Operation & Adjustment

Annually check the switch for proper operation

Set Point Calibration

The set point dial of the GAO and GMH is factory calibrated with increasing pressure (GML: decreasing pressure). Due to hysteresis, the GAO switch will actuate at a slightly lower point as the pressure decreases.

Adjusting the Set Point

1. Remove the clear cover ❶ from the switch.
2. Turn the dial ❷ until the desired trip pressure is opposite the white arrow (mark) on the yellow dial face.
3. After adjusting the set point for normal operation check to see that the gas pressure switch operates as intended.
4. Use an accurate pressure gauge connected upstream from the switch to measure the actual pressure.
5. Replace the clear cover.

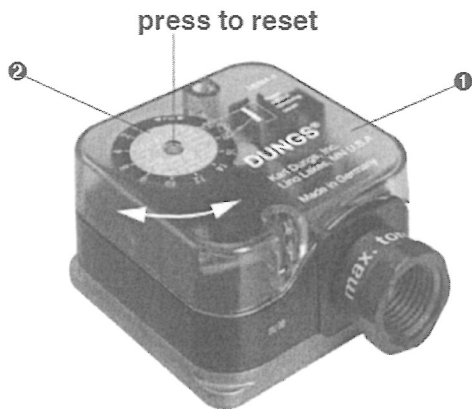

Automatic Reset

The NC contact of the GAO breaks when pressure rises above the set point. It makes automatically when pressure returns to the normal operating level.

Manual Reset

The NC contact of the GMH breaks when pressure rises above the set point. The NO contact of the GML breaks when pressure falls below the set point. Neither of the switches will return to their former position automatically. To reset, wait until the pressure returns to the normal operating level. Then press and release the clear cover over the red reset button in the center of the yellow dial face; it is not necessary to remove the cover. The neon light indicates a fault condition for the GML and GMH series and for the GAO series when used as a high gas limit. The lead for the light wired to terminal #2 on the GAO series should be wired to terminal #1 when used as a low gas limit.

Installation Position

	Standard installation position is vertical upright diaphragm.
	When installed horizontally , the pressure switch switches at a pressure higher by approx. 0.2 in. W.C.
	When installed upside down , the pressure switch switches at a pressure lower by approx. 0.2 in. W.C.
	When installed in other positions , the pressure switch switches at pressure deviating from the set reference value by max. ± 0.2 in. W.C.

Annually check the switch for proper operation

Low Gas Pressure Switch:

1. First, connect a meter capable of reading +/- 0.1 ohms to the NO and COM contacts, and verify that the NO and COM contacts are made. Measure the resistance, and if the resistance is more than 1.0 ohm, remove switch from service. (See terminal illustration below for guidance).
2. Then, verify that the low gas pressure switch will change state when a low gas condition is sensed by connecting a meter capable of reading +/- 0.1 ohms to the NC and COM contacts and then by causing the switch to go into a fault condition. Once the fault occurs, Measure the resistance, and if the resistance is more than 1.0 ohm, remove switch from service.
3. To cause the fault, perform one of the two procedures:
 1. Turn the pressure switch setpoint counterclockwise until the switch trips.
 2. Depressurize the volume of gas the low gas pressure switch is sensing. For FRI/6 regulators, this can be done by opening the side tap on the opposite side of the FRI/6 regulator. For DMV and MBC safety shutoff valves, this can be done opening the port 1 pressure tap. For SV valves, open port 1 of the upstream valve.
4. Allow the burner to go through a startup sequence, and then verify that the burner faults and is not allowed to light off.
5. Close all test taps (ports) and open upstream ball valve.
6. When finished, close all pressure test points used, and then open the upstream ball valve **SLOWLY** to allow gas pressure to gradually bleed into the system.

High Gas Pressure Switch:

1. First, connect a meter capable of reading +/- 0.1 ohms to the NC and COM contacts, and verify that the NC and COM contacts are made. Measure the resistance, and if the resistance is more than 1.0 ohm, remove switch from service.
2. Then, verify that the high gas pressure switch will change state when a high gas condition is sensed by connecting a meter to the NO and COM contacts and then by causing the switch to go into a fault condition.
3. To cause the fault, perform one of the two procedures:
 1. Turn the pressure switch setpoint clockwise until the switch trips.
 2. Pressurize the volume of gas the high gas pressure switch is sensing. This can be done by closing the downstream ball valve, opening port 3 tap on a DMV and MBC safety shutoff valves, or port 2 or 3 of the downstream SV valve, and then using a pump to pressurize the test chamber.
4. Measure the resistance across the NO and COM contacts. If the resistance is more than 1.0 ohm, remove switch from service.
5. Allow the burner to go through a startup sequence, and then verify that the burner faults and is not allowed to light off.
6. When finished, close all test taps (ports) and open the downstream ball valve.

NOTE: A resistance of more than 1.0 ohm indicates that the switch contacts are starting to either corrode or carbonize.

 **Opening the upstream manual valve too fast can permanently damage the pressure switch.**

 **Do not simulate fault conditions while the burner is firing.**

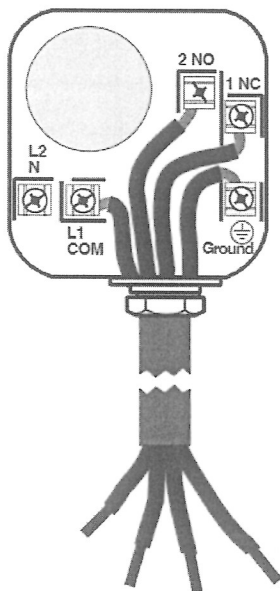

Mounting to Safety Valves

Location

Model series GAO-A2-4, GMH-A2-4, and GML-A2-4 can be mounted directly to various ports on a DUNGS valve. The pressure switch should be mounted in locations meeting the requirements of the applicable code. Order mounting kit 214-975 for DMV port 3 mount and MBC port 3 mounting, and kit 225-047 for mounting switch vertically on a valve flange.

A2 mounting options

DMV 701-703 Dual modular valve

Pressure tap	Mounting possible?
1	yes
2	yes
3	yes, with #214-975
4	yes, horizontal yes, vertical with #225-047
5	yes, horizontal yes, vertical with #225-047

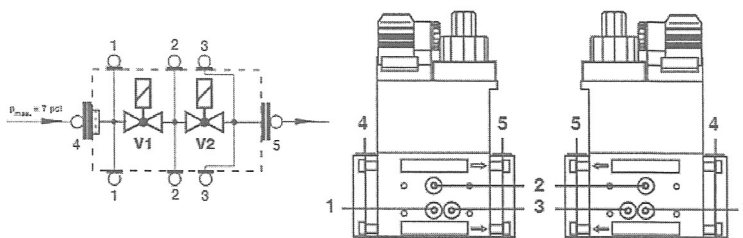

A2 mounting options

SV 1005 and SV 1007 series safety valve

Pressure tap	Mounting possible?
1	no
2	yes
3	no
4	no

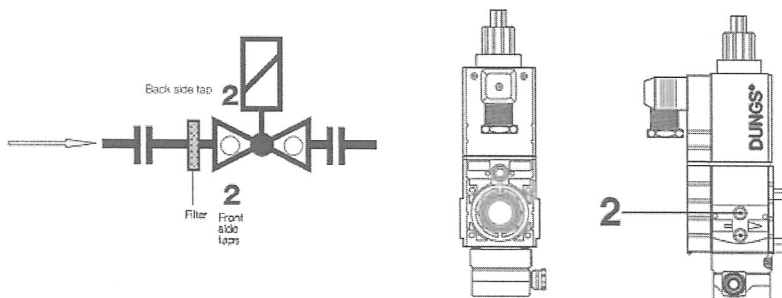

A2 mounting options

SV 1010, SV 1012, SV 1015 and SV 1020 series safety valve

Pressure tap	Mounting possible?
1	yes
2	yes
3	yes
4	no
5	yes

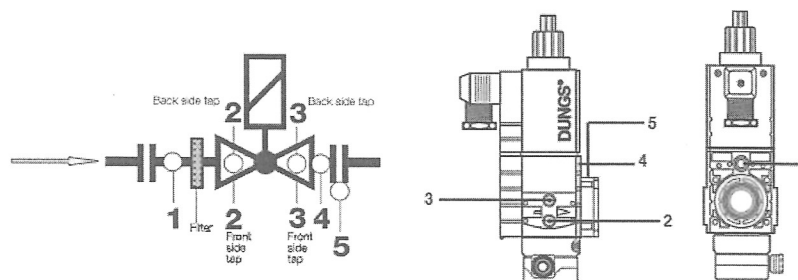

A2 mounting options

MBC series multifunctional control

Pressure tap	Mounting possible?
1	yes, horizontal yes, vertical with #225-047
2	yes
3	yes
4	yes, with #214-975
5	yes, horizontal yes, vertical with #225-047

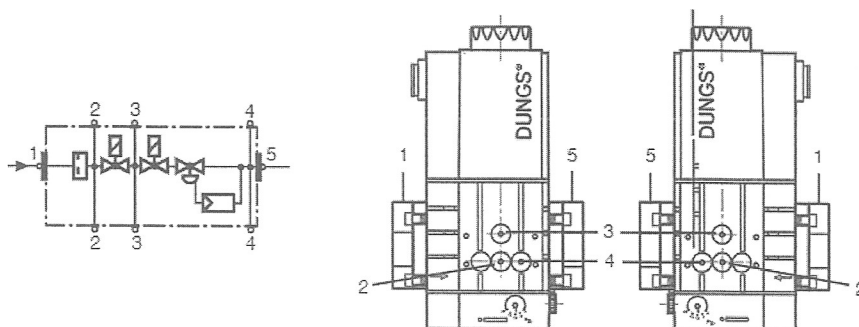

Mounting to Safety Valves or FRI Regulator

A2 mounting options DMV 525, 5040-5125/11 Dual modular valve

Pressure tap	Mounting possible?
1	yes
2	yes
3	yes
4	yes
5	no
6	no

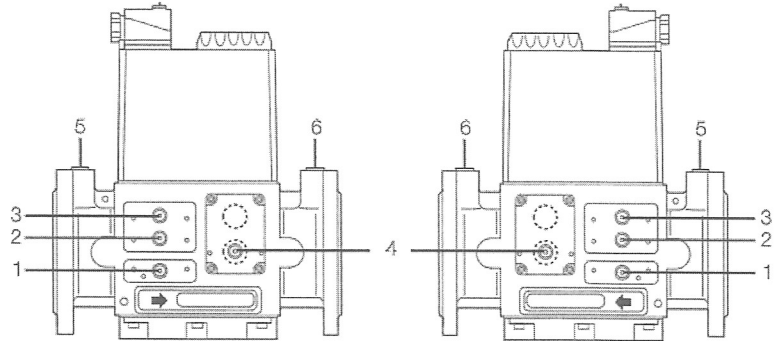
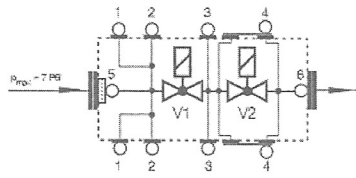

A2 mounting options FRI gas pressure regulator

Pressure tap	Mounting possible?
1	yes
2	yes
3	yes

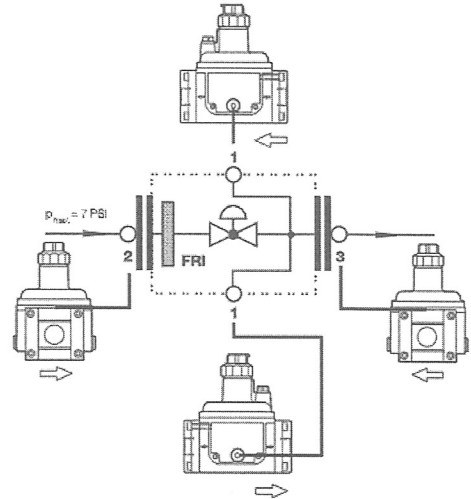

Accessories & Replacement	
Accessory for pressure switch	Order No.
Replacement cover (screws not included)	228-732 (for GAO switches) and 233-113 (for GMH and GML switches)
Screw for replacement cover (100 pcs)	237-675
PG 11 - 1/2" NPT conduit adapter (10 pcs)	231-214
PG 11 - 1/2" NPT conduit adapter (1 pcs)	220-566
120 VAC light mounting set (orange)	231-772
120 VAC light only (standard)	244-156 (for switches with kit 231-772 already installed)
24 VDC/VAC light mounting set (orange)	231-774
120 VAC light mounting set (green)	248-240
DIN connector (female plug)	210-318
Male plug for DIN connector	219-659 (for GAO switches) and 227.644 (for GMH and GML switches)
Mounting screw kit	226-188 (includes o-ring and two M4 thread forming screws)
M20 - 1/2" NPT Adapter	240-671
Port 3 adapter	214-975 (for MBC 1000-4000 series and DMV 701-703 series)
Adapter with 1/4" NPT threaded connection and pressure tap for vertically mounting pressure switch on a SV, DMV or MBC valve flange.	225-047

We reserve the right to make modifications in the course of technical development.