

Honeywell

krom
schroder

Tightness controls TC

Technical Information · GB
3 Edition 04.17

- Adjustable test period which can be adapted to different systems
- Adjustable test instant allows quick system start
- Maximum safety thanks to self-monitoring electronics



Safety manual for products complying with EN 61508-2

Contents

Tightness controls TC	1	3.1.9 Calculation example for t_M	27
Contents	2	3.2 TC 4	28
1 Application	4	3.2.1 Connection diagram	28
1.1 Application examples	7	3.2.2 Test procedure TC 4	29
1.1.1 TC 1V with valVario controls	7	3.2.3 TC 4 test instant	31
1.1.2 TC 1C with combination control CG..D or CG..V	8	3.2.4 Test instant for Mode 1: testing before burner run	31
1.1.3 TC 2 with two gas solenoid valves	9	3.2.5 Test instant for Mode 2: testing after burner run	32
1.1.4 TC 2 with two gas solenoid valves and one auxiliary valve for discharge	10	3.2.6 Test period t_P for TC 4	33
1.1.5 TC 2 with two gas solenoid valves and one auxiliary valve for discharge	11	3.2.7 Calculation example for t_P	33
1.1.6 TC 2 in a multiple burner system with several valves installed in series	12	3.3 Test volume V_P for TC 1, TC 2, TC 3, TC 4	34
1.1.7 TC 3 in a multiple burner system with several valves installed in series	13	3.4 Leakage rate Q_L	35
1.1.8 TC 4 with two gas solenoid valves	14	3.5 Animation	36
1.1.9 TC 4 with two gas solenoid valves and one auxiliary valve for discharge	15	4 Selection	37
1.1.10 TC 4 in a multiple burner system with two auxiliary valves for supply and discharge	16	4.1 TC 1, TC 2, TC 3	37
1.1.11 TC 4 in a multiple burner system with several valves installed in series	17	4.1.1 Selection table	37
2 Certification	18	4.1.2 Type code	37
2.1 TC 1, TC 2, TC 3	18	4.2 TC 4	37
2.2 TC 4	19	4.2.1 Selection table	37
3 Function	20	4.2.2 Type code	37
3.1 TC 1, TC 2, TC 3	20	5 Project planning information	38
3.1.1 Connection diagrams for TC 1, TC 2	20	5.1 Selecting the auxiliary valves	38
3.1.2 Connection diagrams for TC 3	21	5.2 Start rate	39
3.1.3 Test procedure for TC 1, TC 2, TC 3	22	5.3 Installation	39
3.1.4 Test instant TC 1, TC 2, TC 3	24	5.3.1 TC 1V for solenoid valves for gas VAS, VCx	39
3.1.5 Test instant for Mode 1: testing before burner run	24	5.3.2 TC 1C for combination controls CG	39
3.1.6 Test instant for Mode 2: testing after burner run	25	5.3.3 TC 2	40
3.1.7 Test instant for Mode 3: testing before and after burner run	26	5.3.4 TC 3	40
3.1.8 Measurement time t_M for TC 1, TC 2, TC 3	27	5.3.5 TC 4	40
		5.4 Electrical connection of TC 1, TC 2	41
		5.5 Determining the relief line size	41
		6 Accessories	42
		6.1 Socket	42
		6.2 Valve connection cable	42
		6.3 External pressure switch for TC 4	42

7 Technical data	43
7.1 TC 1, TC 2, TC 3	43
7.2 TC 4	44
7.3 Indicators and operating controls	46
7.4 Dimensions	47
7.5 Converting units	47
7.6 Safety-specific characteristic values	48
8 Safety information in accordance with EN 61508-2 for TC 1, TC 2, TC 3	49
8.1 General	49
8.1.1 Type of action	49
8.1.2 Other classifications	49
8.1.3 Electrical data	49
8.2 Interfaces	50
8.2.1 Electrical wiring	50
8.2.2 Connection terminals	50
8.2.3 Inputs	50
8.2.4 Outputs	51
8.3 SIL and PL for TC 1, TC 2, TC 3	51
9 Maintenance cycles	52
10 Glossary	53
10.1 Tightness control	53
10.2 Valve proving system VPS	53
10.3 Safety interlocks	53
10.4 Diagnostic coverage DC	53
10.5 Operating mode	53
10.6 Hardware fault tolerance HFT	53
10.7 Probability of dangerous failure PFH_D	54
10.8 Mean time to dangerous failure $MTTF_d$	54
Feedback	55
Contact	55

1 Application



TC 1, TC 2

TC 3

TC 4

The tightness control TC checks the fail-safe function of both valves before each start-up or after each shut-down of a system with two safety valves.

The aim is to identify an inadmissible leak on one of the gas valves and to prevent burner start. The other gas valve continues working properly and takes over the safe shut-off of the gas supply.

It is used in industrial thermoprocessing equipment, on boilers and on forced draught burners.

Standards ISO 13577-2, EN 746-2 and EN 676 stipulate tightness controls for capacities over 1200 kW (NFPA 86: from 117 kW or 400,000 Btu/h in conjunction with a visual indicator). Pre-purge of the combustion chamber can be dispensed with under certain conditions in accordance with EN 746-2, if a tightness

control is used. In this case, the system must be vented into a safe area.

TC 1V, TC 1C

Tightness control TC 1V can be directly flange-mounted to all valVario controls. There is only one version for all sizes.

TC 1C can be used for combination controls CG 1 to 3. An adapter plate is supplied for installation.

TC 2 and TC 4

Tightness controls TC 2 and TC 4 can be used with gas solenoid valves of any nominal size, which are quick opening or slow opening with start rate. It is possible to conduct a tightness test on pneumatically operated or slow opening valves without start rate by using additional auxiliary valves.

Slow opening motorized valves VK up to DN 65 which are directly flanged together can also be checked by TC 2 and TC 4 within a temperature range of 0 to 60°C (32 to 140°F).

An adapter plate is provided for installation of the TC 2.

TC 3

Tightness control TC 3 is a universal device for quick and slow opening gas solenoid valves of any nominal size as well as for motorized valves. The tightness test is carried out with the valves installed in TC 3.

TC 4

Tightness control TC 4 consists of detection circuitry and can be installed in the control cabinet, separately from the system. An external pressure switch takes over the mechanical pressure test between the valves. Tightness control TC 4 is independent of gas type and inlet pressure p_u and can be used for a test period of up to 10 minutes with a large test volume.

Application

TC 1V on a valVario double solenoid valve

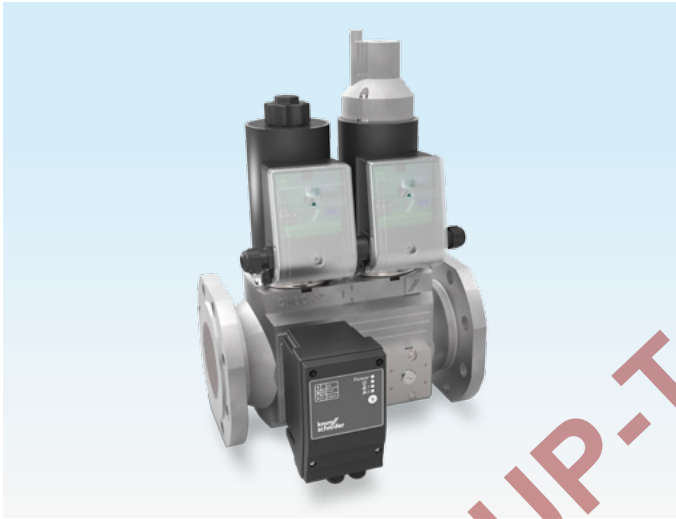

TC 4 installed separately from the system in a control cabinet



NOT UP-TO-DATE
www.docuthek.com

1.1 Application examples

PZ = Internal pressure sensor of the TC for the comparison of inlet pressure p_u and interspace pressure p_z

p_d = Outlet pressure

V_p = Test volume

1.1.1 TC 1V with valVario controls

Mains voltage = control voltage

V1: quick or slow opening valve with start rate.

V2: pressure regulator with solenoid valve.

Tightness control TC 1V checks gas solenoid valves V1 and V2 and the pipe between the valves for tightness.

If both valves are tight, the TC forwards the OK enable signal to the automatic burner control unit GFA. This opens valves V1 and V2 simultaneously. The burner starts.

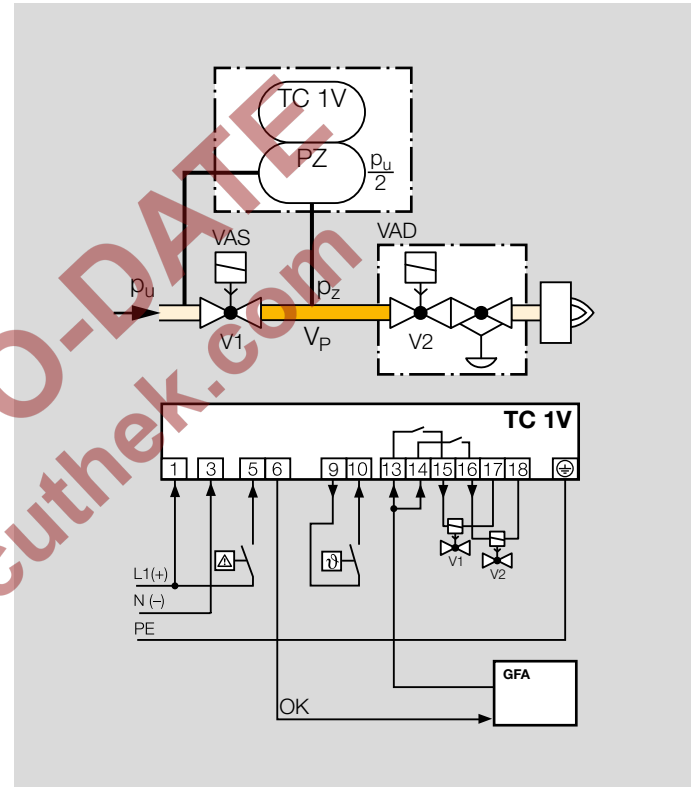

Application

1.1.2 TC 1C with combination control CG..D or CG..V

Mains voltage = control voltage

V1 and V2: quick opening valves.

TC 1C is directly flange-mounted to combination control CG..D or CG..V and checks gas solenoid valves V1 and V2 in the combination control for tightness.

Once the tightness test has been carried out successfully, the tightness control forwards the OK enable signal to the automatic burner control unit GFA. This opens valves V1 and V2 in the combination control CG simultaneously. The burner starts.

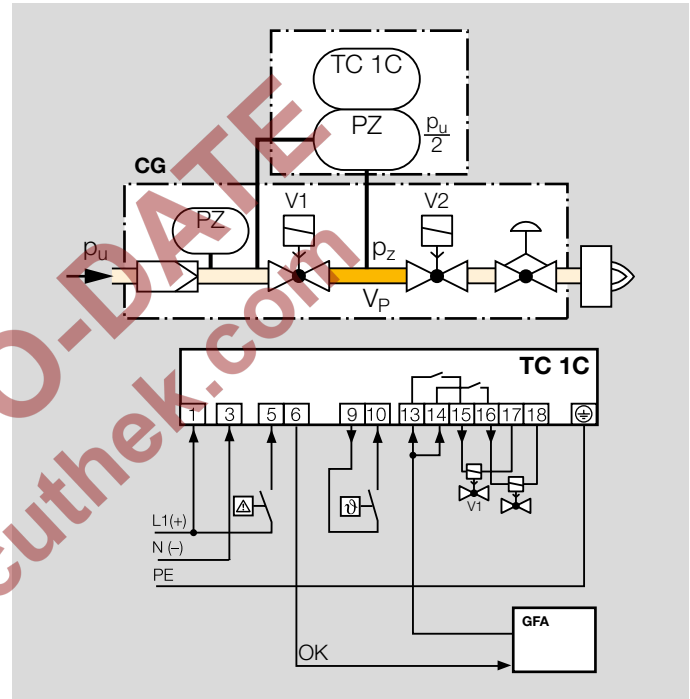

Application

1.1.3 TC 2 with two gas solenoid valves

Mains voltage = control voltage

V1 and V2: quick or slow opening valves with start rate.

TC 2 checks gas solenoid valves V1 and V2 and the pipe between the valves for tightness.

If both valves are tight, the TC forwards the OK enable signal to the automatic burner control unit GFA. This opens valves V1 and V2 simultaneously. The burner starts.

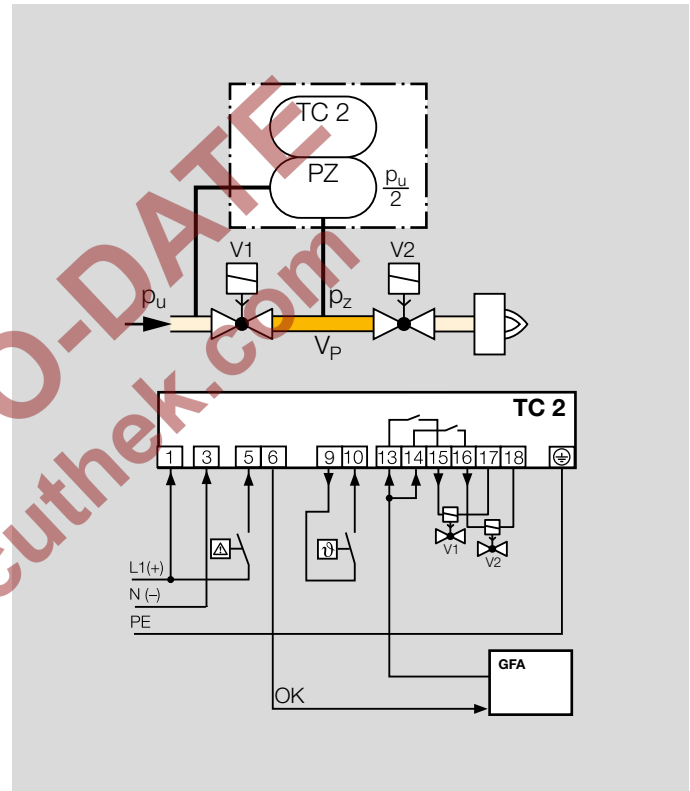

Application

1.1.4 TC 2 with two gas solenoid valves and one auxiliary valve for discharge

Mains voltage = control voltage

V1 and V2: quick or slow opening valves with start rate.
V3: quick or slow opening valve with start rate, nominal size is dependent on test volume V_P and inlet pressure p_u , see page 38 (Project planning information), but is at least DN 15.

TC 2 checks gas solenoid valves V1, V2, the auxiliary valve V3 and the pipe between the valves for tightness. It must be ensured that the interspace p_z is vented during the 3-second opening time. This is not guaranteed by the gas pressure regulator downstream of V2. A relief line is thus used to discharge the test volume V_P safely into the combustion chamber or into a safe area. Auxiliary valve V3 can also be used as a pilot gas valve. Since valve V2 remains closed during the test, it can also be a slow opening motorized valve VK.

Once the tightness test has been carried out successfully, the tightness control forwards the OK enable signal to the automatic burner control unit GFA. The GFA opens the gas solenoid valves V1 and V2 simultaneously. The burner starts.

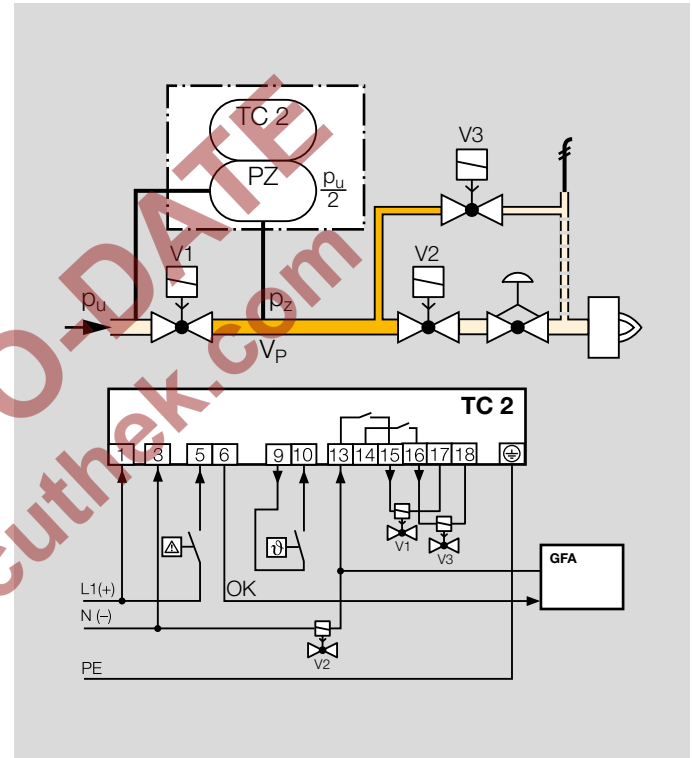

Application

1.1.5 TC 2 with two gas solenoid valves and one auxiliary valve for discharge

Mains voltage = control voltage

V1: quick or slow opening valve with start rate.

V2: any.

V3: quick opening, nominal size is dependent on test volume V_P and inlet pressure p_u , see page 38 (Project planning information), but is at least DN 15.

TC 2 checks gas solenoid valves V1, V2, the auxiliary valve V3 and the pipe between the valves for tightness. If all the gas solenoid valves are tight, the tightness control forwards the OK enable signal to the automatic burner control unit GFA. The GFA opens the gas solenoid valves V1 and V2 simultaneously. The burner starts.

A relief line is used to discharge the test volume V_P into a safe area. Thanks to the installed auxiliary valve V3, valve V2 can also be a slow opening motorized valve VK.

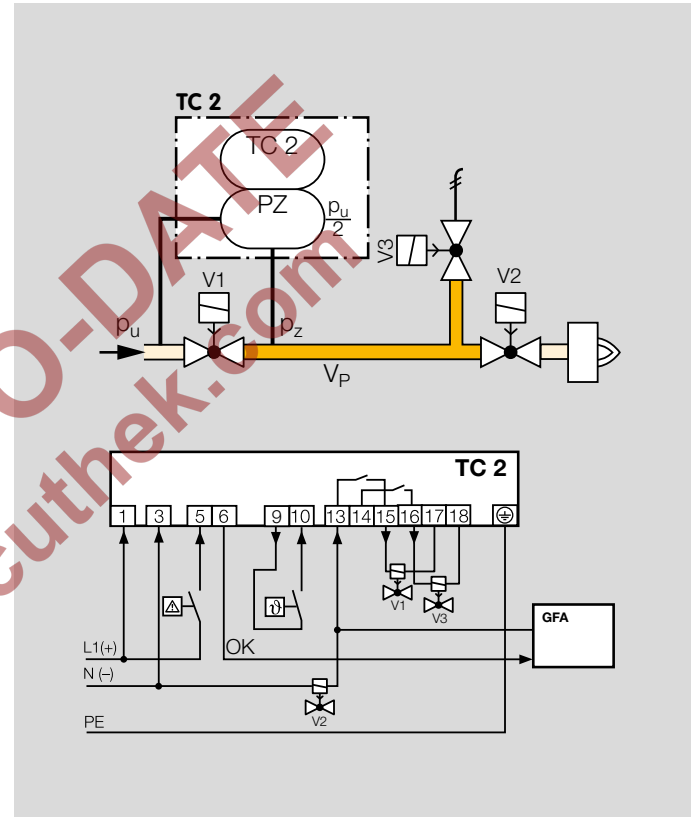

Application

1.1.6 TC 2 in a multiple burner system with several valves installed in series

Mains voltage = control voltage

V3 and V4: quick opening, nominal size is dependent on test volume V_P and inlet pressure p_u , see page 38 (Project planning information), but is at least DN 15.

When using slow opening main valves (V1 and V2), auxiliary valves (V3 and V4) must be used for the supply and discharge of the test volume V_P .

TC 2 checks the central shut-off valve V1, the gas solenoid valve V2, the auxiliary valves V3 and V4 and the pipe between these valves for tightness.

Valve V2 can only be checked for tightness when the pressure downstream of V2 approximately corresponds to the atmospheric pressure and the volume downstream of valve V2 is $5 \times V_P$. The gas solenoid valve VAS and the pressure switch DG_{VAS} are used to relieve the pressure. The pressure switch must be adjusted in such a way so that enough pressure is relieved and no air can get into the pipework.

Once the tightness test has been carried out successfully, TC 2 opens the main valves V1 and V2 with the OK enable signal and enables the downstream burner control units.

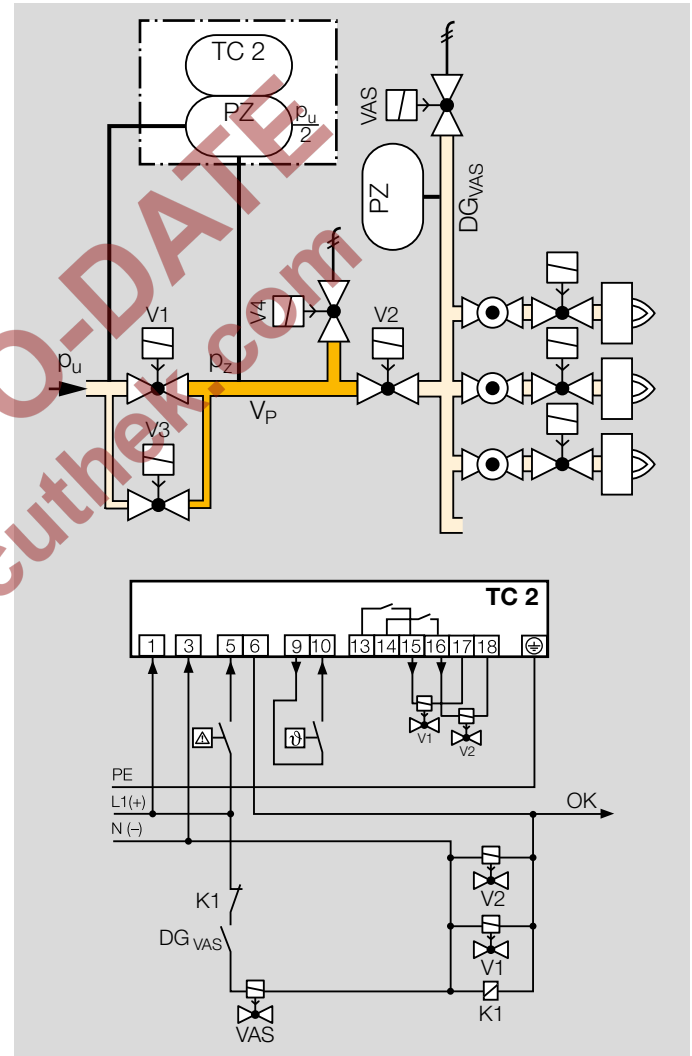

Application

1.1.7 TC 3 in a multiple burner system with several valves installed in series

V1 and V2: any.

TC 3 checks slow opening main valves V1 and V2 and the pipe between these valves for tightness.

The test volume V_p is supplied and discharged via the TC 3 auxiliary valves.

Valve V2 can only be checked for tightness when the pressure downstream of V2 approximately corresponds to the atmospheric pressure and the volume downstream of valve V2 is $5 \times V_p$. The gas solenoid valve VAS and the pressure switch DG_{VAS} are used to relieve the pressure. The pressure switch must be adjusted in such a way so that enough pressure is relieved and no air can get into the pipework.

Once the tightness test has been carried out successfully, TC 3 opens the main valves V1 and V2 with the OK enable signal and enables the downstream burner control units.

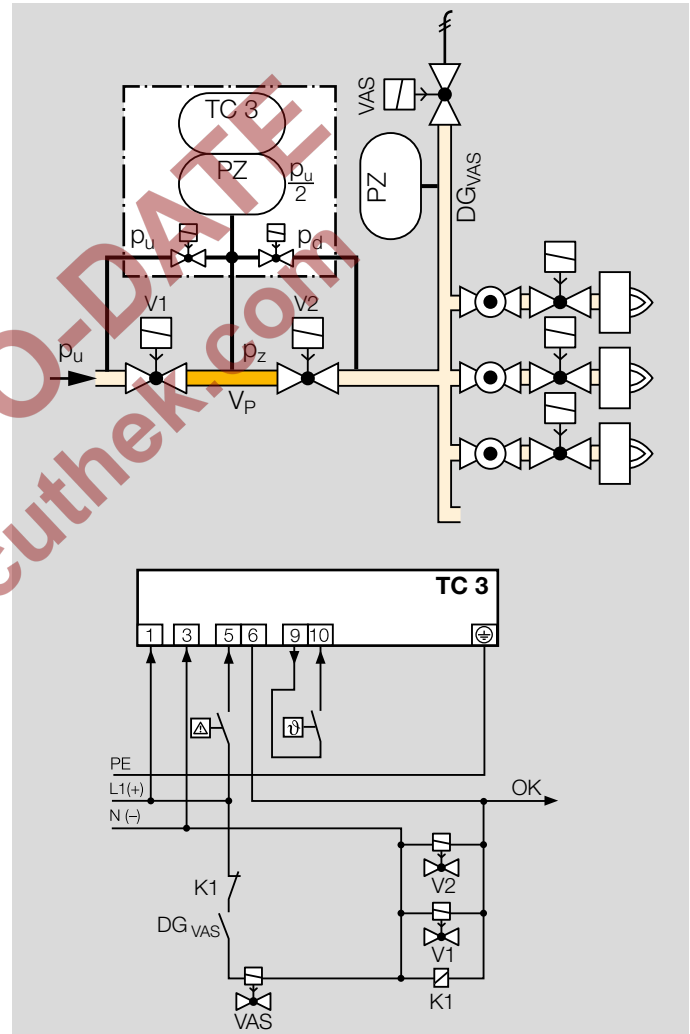

Application

1.1.8 TC 4 with two gas solenoid valves

V1 and V2: quick or slow opening valves with start rate.

TC 4 checks gas solenoid valves V1 and V2 and the pipe between the valves for tightness.

The external pressure switch DG monitors the pressure between the two valves.

Once the tightness test has been carried out successfully, TC 4 forwards the OK enable signal to the automatic burner control unit GFA. The GFA opens the gas solenoid valves V1 and V2 simultaneously. The burner starts.

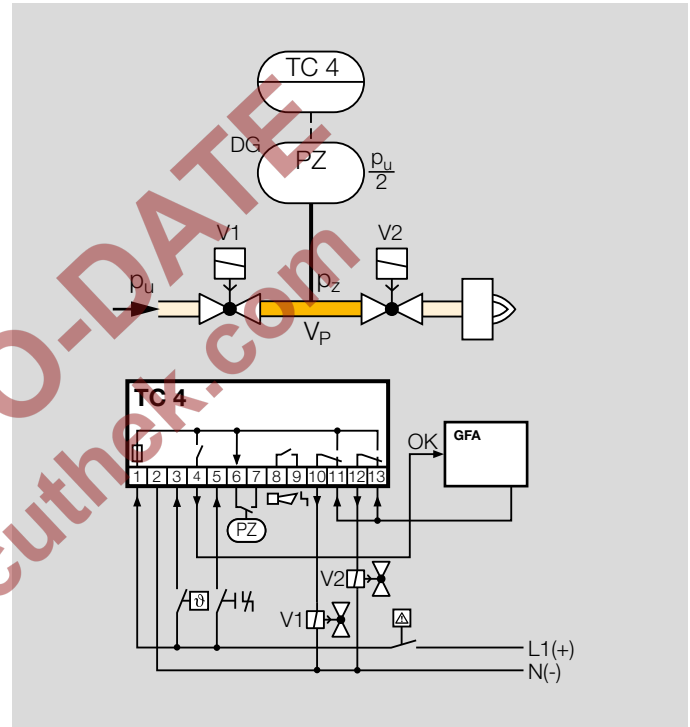

Application

1.1.9 TC 4 with two gas solenoid valves and one auxiliary valve for discharge

V1: quick or slow opening valve with start rate.

V2: any.

V3: quick opening, nominal size is dependent on test volume V_P and inlet pressure p_u , see page 38 (Project planning information), but is at least DN 15.

TC 4 checks gas solenoid valves V1, V2, the auxiliary valve V3 and the pipe between the valves for tightness. It must be ensured that the interspace p_z is vented during the 2-second opening time. This is not guaranteed by the gas pressure regulator downstream of V2. A relief line is thus used to discharge the test volume V_P safely into the combustion chamber or into a safe area. Since valve V2 remains closed during the test, it can also be a slow opening motorized valve VK.

If all the gas solenoid valves are tight, TC 4 forwards the OK enable signal to the automatic burner control unit GFA. The GFA opens the gas solenoid valves V1 and V2 simultaneously. The burner starts.

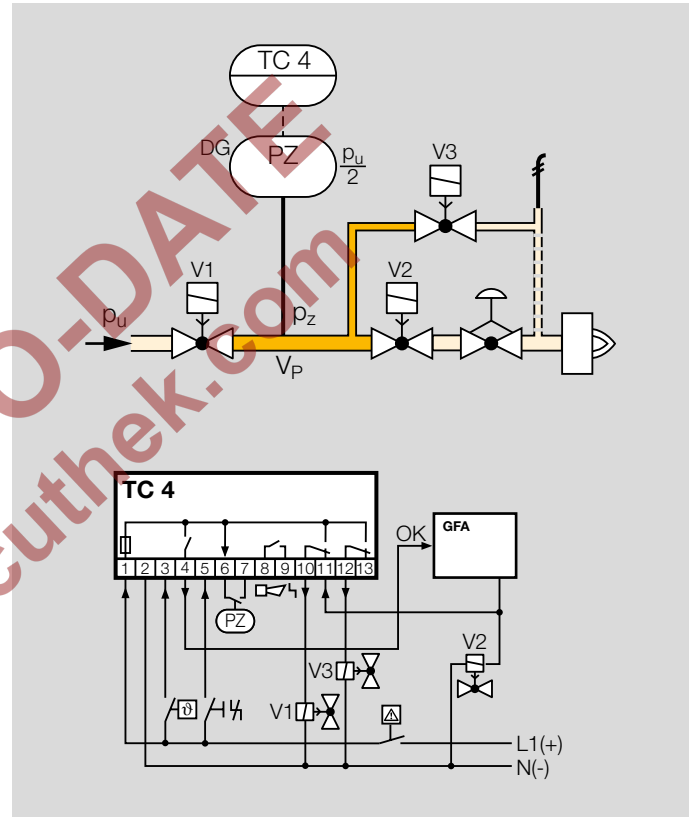

1.1.10 TC 4 in a multiple burner system with two auxiliary valves for supply and discharge

V1: any.

V2 and V3: quick opening, nominal size is dependent on test volume V_P and inlet pressure p_u , see page 38 (Project planning information), but is at least DN 15.

TC 4 checks the central shut-off valve V1, the auxiliary valves V2 and V3, the burner valves and the pipe between these valves for tightness.

The test volume V_P is supplied via the auxiliary valve V3. The external pressure switch DG monitors the pressure between the gas solenoid valves V1, V2 and the burner valves.

Once the tightness test has been carried out successfully, TC 4 opens gas solenoid valve V1. The TC forwards the OK enable signal simultaneously to the automatic burner control units for the burner valves. The burner valves open and the burners start.

Thanks to the relief line and auxiliary valve V2, the test volume V_P is discharged into a safe area or into the combustion chamber.

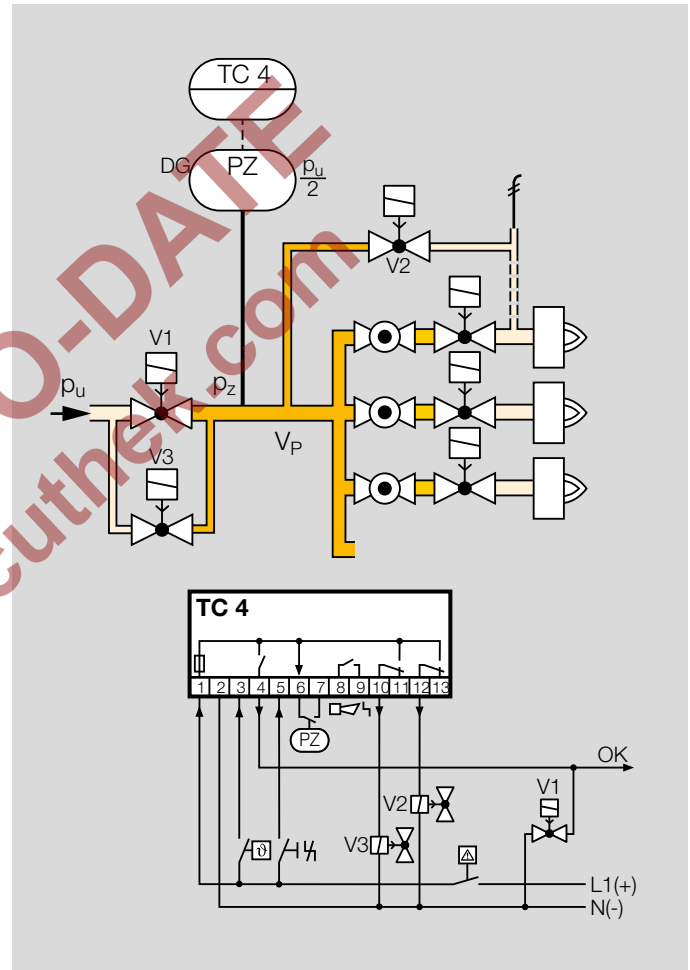

1.1.11 TC 4 in a multiple burner system with several valves installed in series

V1 and V2: quick or slow opening valves with start rate.
 Tightness control TC 4 checks the central shut-off valve V1, the gas solenoid valve V2 and the pipe between these valves for tightness.

Valve V2 can only be checked for tightness when the pressure downstream of V2 approximately corresponds to the atmospheric pressure. The gas solenoid valve VAS and the pressure switch DG_{VAS} are used to relieve the pressure. The pressure switch must be adjusted in such a way so that enough pressure is relieved and no air can get into the pipework.

After the thermostat/start-up signal ϑ has been applied, first DG_{VAS} is checked. If the pressure downstream of V2 is correct, the VAS closes and the tightness test is started.

Once the tightness test has been carried out successfully, TC 4 opens the main valves V1 and V2 with the OK enable signal and enables the downstream burner control units.

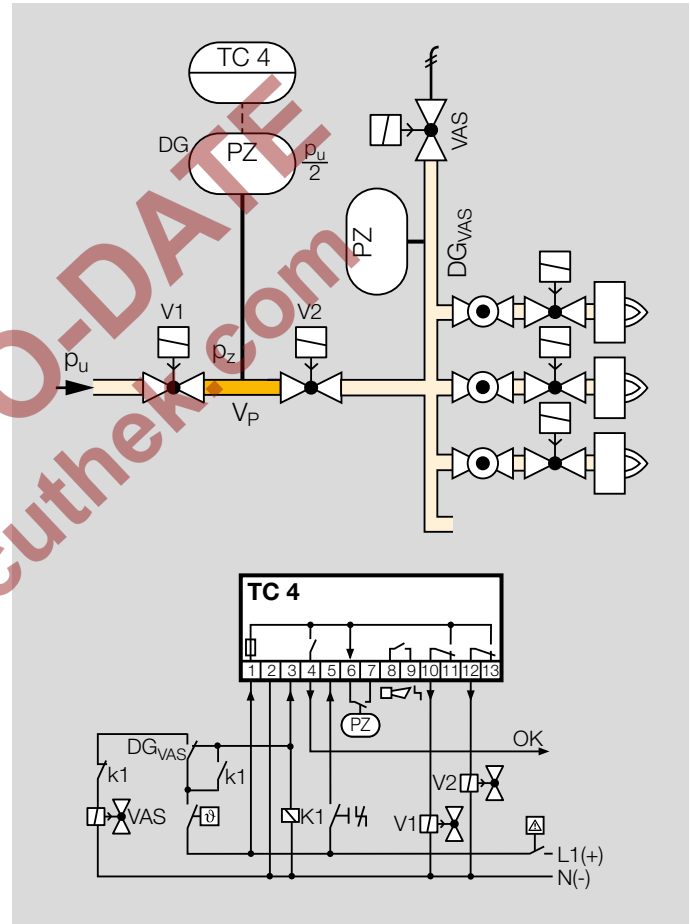

2 Certification

Certificates – see Docuthek.

2.1 TC 1, TC 2, TC 3

Certified pursuant to SIL



For systems up to SIL 3 pursuant to EN 61508.

Pursuant to EN ISO 13849-1, Table 4, TC 1, TC 2 and TC 3 can be used up to PL e.

EU certified pursuant to



Directives:

- Gas Appliances Directive 2009/142/EC (valid until 20 April 2018) in conjunction with EN 1643, EN 60730 and EN 61000-6-2
- Low Voltage Directive (2014/35/EU)
- EMC Directive (2014/30/EU)

Regulation:

- Gas Appliances Regulation (EU) 2016/426 (valid from 21 April 2018)

2.2 TC 4

EU certified pursuant to



- Tightness control TC complies with the requirements set out in section 5.2.2.3.4 of EN 746-2. It achieves a safety level equivalent to EN 1643.
Scan of the Declaration of conformity (D, GB) – see Docuthek.

FM approved

230 V



Factory Mutual Research Class: 7400 and 7411 Safety overpressure slam shut valves. Designed for applications pursuant to NFPA 85 and NFPA 86. www.approvalguide.com

UL listed

USA and Canada

120 V



Standard: UL 353 Limit control. Link to Underwriters Laboratories – www.ul.com → Tools (at the bottom of the page) → Online Certifications Directory

Canadian Standards Association: CSA-C22.2 No. 24

AGA approved



Australian Gas Association, Approval No.: 4581
http://www.aga.asn.au/product_directory

Eurasian Customs Union



The product TC 4 meets the technical specifications of the Eurasian Customs Union.

3 Function

3.1 TC 1, TC 2, TC 3

3.1.1 Connection diagrams for TC 1, TC 2

TC 1..W/W, TC 1..Q/Q, TC 1..K/K,
TC 2..W/W, TC 2..Q/Q or TC 2..K/K

Mains voltage = control voltage
24 V DC, 120 V AC or 230 V AC,
see page 37 (Selection).

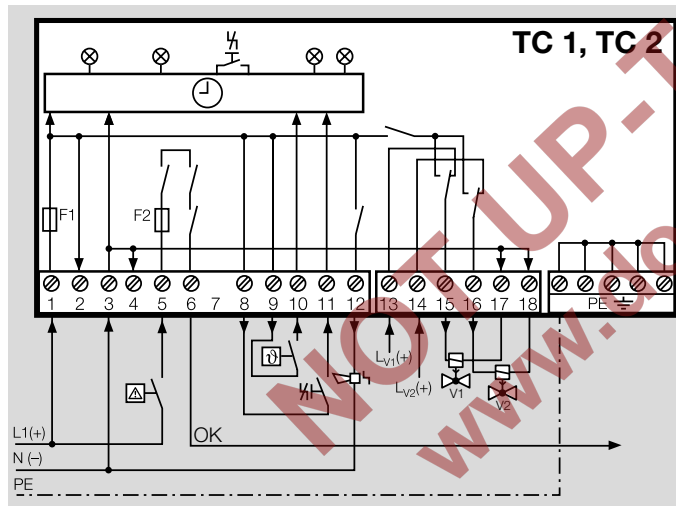

V1 = inlet valve, V2 = outlet valve.

Remote reset by applying control voltage to terminal 11
or via a floating contact between terminals 8 and 11.

TC 1..W/K, TC 1..Q/K, TC 2..W/K or TC 2..Q/K

Mains voltage: 120 V AC or 230 V AC

Control voltage: 24 V DC,
see page 37 (Selection).

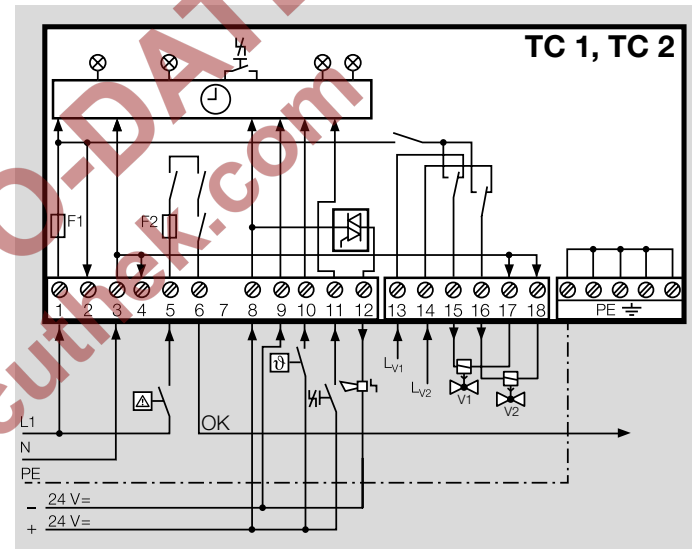

V1 = inlet valve, V2 = outlet valve.

Remote reset by applying control voltage (+ 24 V) to terminal 11.

3.1.2 Connection diagrams for TC 3

TC 3..W/W, TC 3..Q/Q or TC 3..K/K

Mains voltage = control voltage
 24 V DC, 120 V AC or 230 V AC,
 see page 37 (Selection).

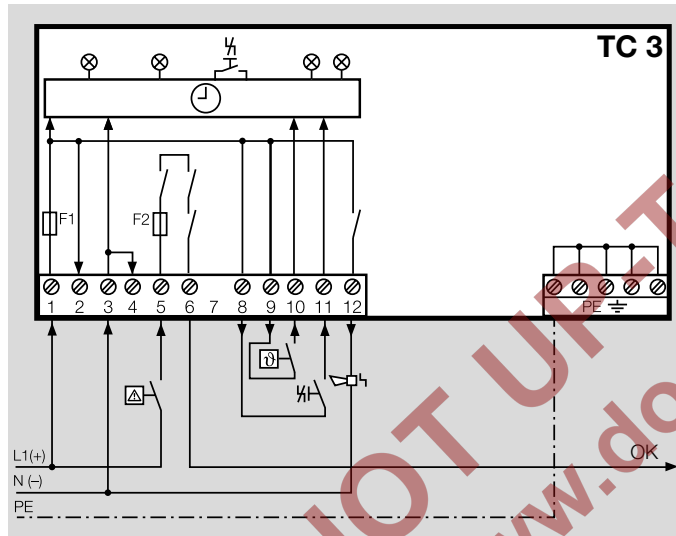

Remote reset by applying control voltage to terminal 11 or via a floating contact between terminals 8 and 11.

TC 3..W/K or TC 3..Q/K

Mains voltage: 120 V AC or 230 V AC
 Control voltage: 24 V DC,
 see page 37 (Selection).

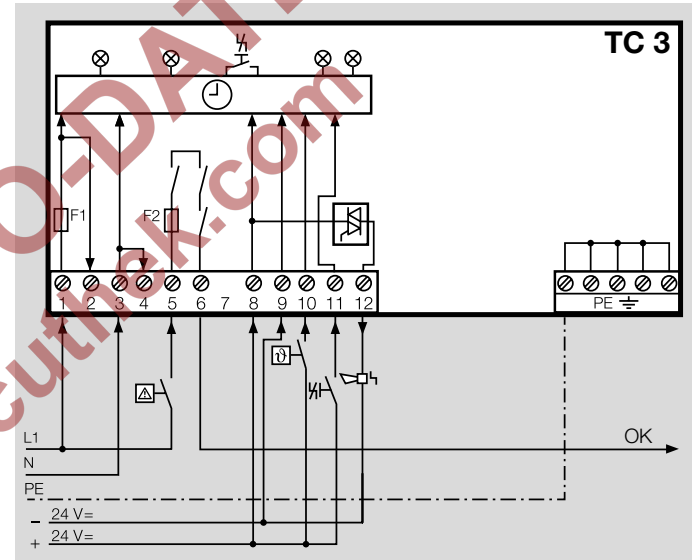

Remote reset by applying control voltage (+ 24 V) to terminal 11.

3.1.3 Test procedure for TC 1, TC 2, TC 3

Depending on the pressure between the valves p_z , the tightness control TC carries out a check using test procedure **A** or **B**:

If pressure $p_z > p_u/2$, program A starts.

If pressure $p_z < p_u/2$, program B starts, see page 23 (Test procedure B).

Test procedure A

Valve V1 opens for the opening time $t_L = 3$ s and closes again. During the measurement time t_M , the tightness control checks the pressure p_z between the valves.

If pressure p_z is less than half the inlet pressure $p_u/2$, valve V2 is leaking.

If pressure p_z is greater than half the inlet pressure $p_u/2$, valve V2 is tight. Valve V2 is opened for the set opening time t_L . V2 closes again.

During the measurement time t_M , the tightness control checks the pressure p_z between the valves.

If pressure p_z is greater than half the inlet pressure $p_u/2$, valve V1 is leaking.

If pressure p_z is less than half the inlet pressure $p_u/2$, valve V1 is tight.

The tightness test can only be performed if the pressure downstream of V2 is around atmospheric pressure.

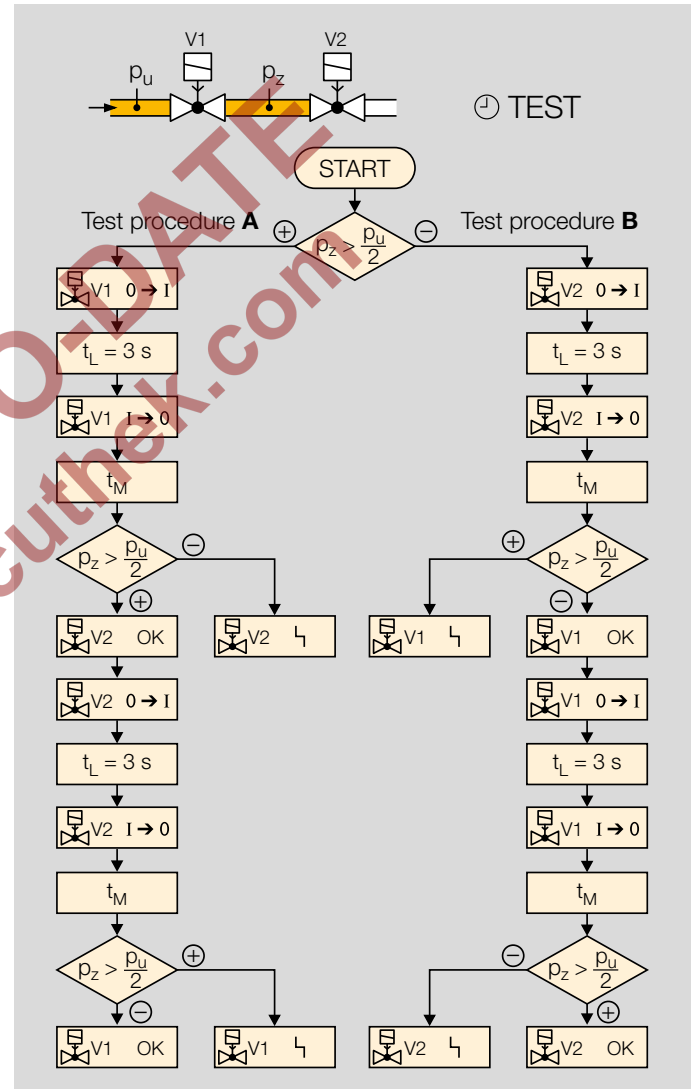

Test procedure B

Valve V2 opens for the opening time $t_L = 3$ s and closes again. During the measurement time t_M , the tightness control checks the pressure p_z between the valves.

If pressure $p_z > p_U/2$, valve V1 is leaking.

If pressure $p_z < p_U/2$, valve V1 is tight. Valve V1 is opened for the set opening time t_L . V1 closes again.

During the measurement time t_M , the tightness control checks the pressure p_z between the valves.

If pressure $p_z < p_U/2$, valve V2 is leaking.

If pressure $p_z > p_U/2$, valve V2 is tight.

The tightness test can only be performed if the pressure downstream of V2 is around atmospheric pressure and the volume downstream of V2 is at least 5 x higher than the volume between the valves.

If the power fails briefly during the test or during operation, the TC will restart in accordance with the test procedure described above.

If there is a fault message, the fault is displayed again after a power failure.

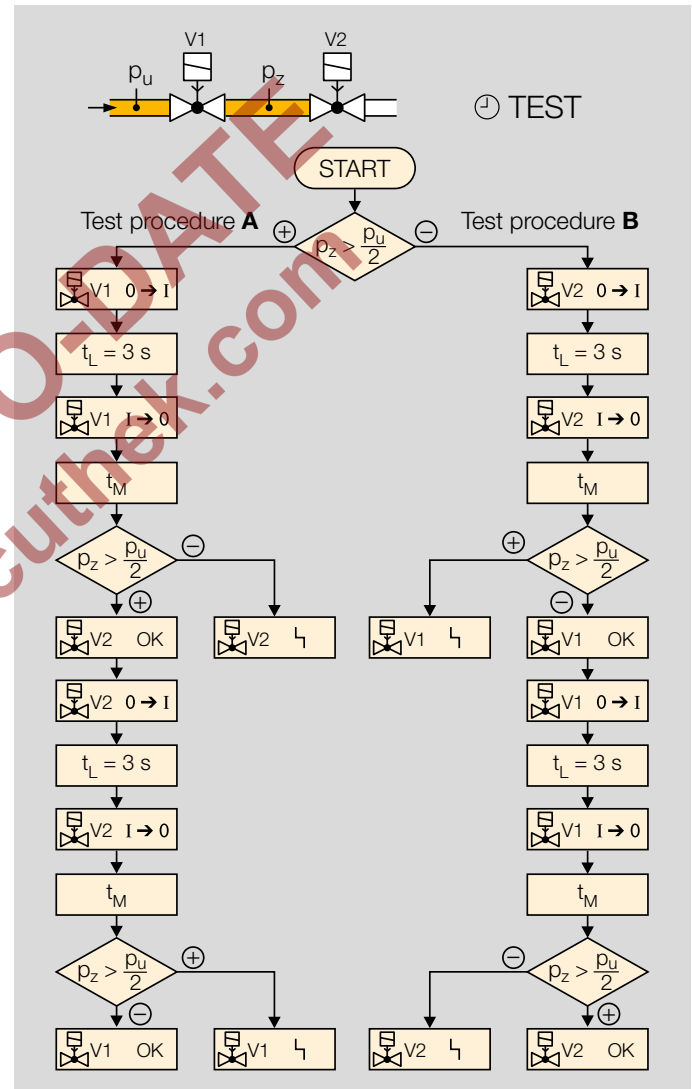

Function

3.1.4 Test instant TC 1, TC 2, TC 3

Two DIP switches are used to determine whether the tightness of the gas solenoid valves is to be checked before burner run, after burner run, or before and after burner run.

3.1.5 Test instant for Mode 1: testing before burner run

Mode 1 = factory setting.

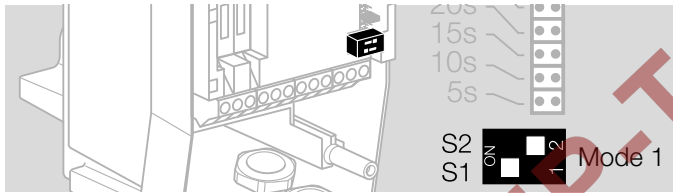

Mains voltage L1 is switched on. In the case of untested valves, the LEDs $\text{L1} \circ$ and $\text{L2} \circ$ are yellow.

The tightness test starts with incoming thermostat/start-up signal 9 . If the valves are tight, the LEDs $\text{L1} \circ$ and $\text{L2} \circ$ are green. Once the safety interlock input signal A is active, the OK enable signal is forwarded to the automatic burner control unit.

The tightness test is valid for up to 24 hours. If the safety interlock input signal A is not connected during this time, the test is started again with the application of the safety interlock input signal. Once the test has been completed successfully, the OK enable signal is issued.

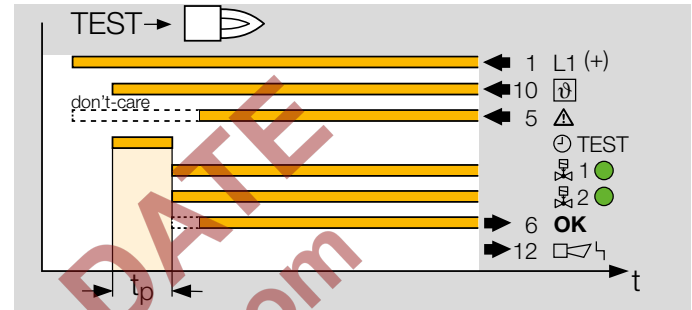

Leaks

If the tightness control TC detects a leak on one of the two valves, the red LED lights up for a fault on valve V1 $\text{L1} \circ$ or valve V2 $\text{L2} \circ$. A fault is signalled externally L4 , e.g. by switching on a buzzer or a warning light.

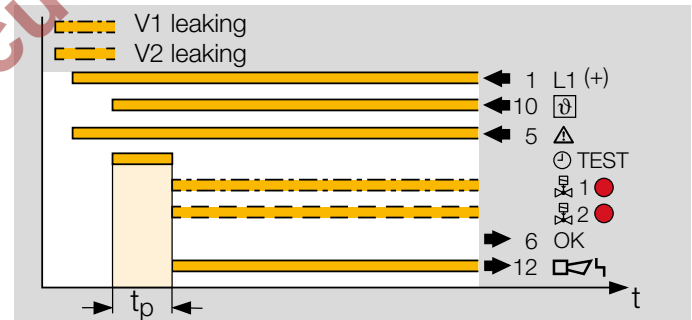

3.1.6 Test instant for Mode 2: testing after burner run

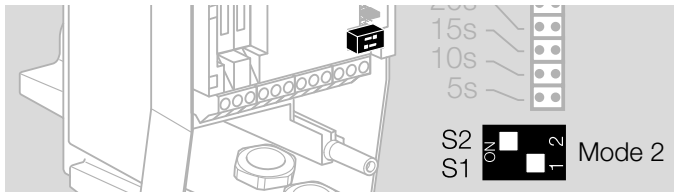

The tightness test after burner run begins as soon as the burner is switched off.

To ensure that the valves are checked for tightness once before starting up the system, the tightness test runs when the mains voltage (L1) is applied or after a reset. If the valves are tight, the LEDs L1 and L2 are green. The OK enable signal is not forwarded to the automatic burner control unit until the thermostat/start-up signal S and the safety interlock input signal Δ have been applied.

The tightness test after burner run starts when the thermostat/start-up signal S drops. The OK enable signal is only forwarded to the automatic burner control unit again once the thermostat/start-up signal S and the safety interlock input signal Δ have been re-applied.

The tightness test is valid for 24 hours. If the thermostat/start-up signal S and the safety interlock input signal Δ are connected during this time, a new tightness test must not be carried out before burner run and the OK enable signal is set. However, if the 24 hours have elapsed, a new tightness test is carried out before burner run.

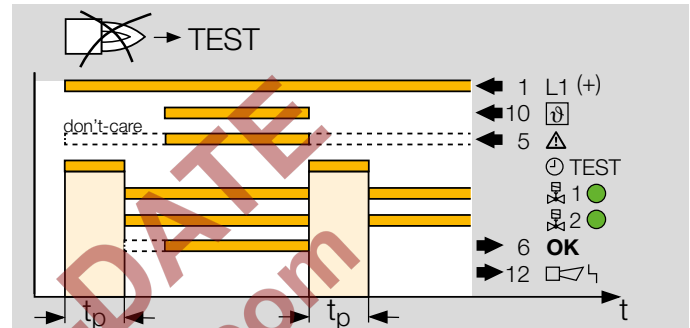

Leaks

If the tightness control TC detects a leak on one of the two valves, the red LED lights up for a fault on valve V1 L1 or valve V2 L2 . A fault is signalled externally L , e.g. by switching on a buzzer or a warning light.

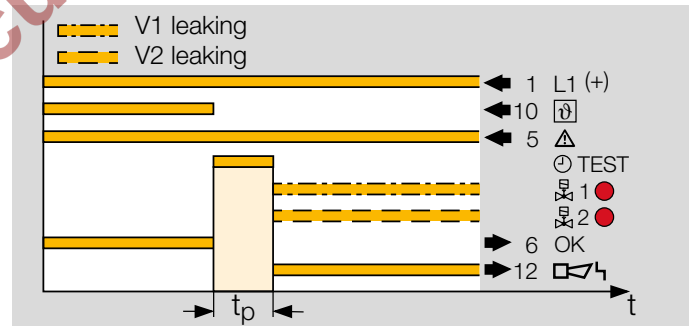

3.1.7 Test instant for Mode 3: testing before and after burner run

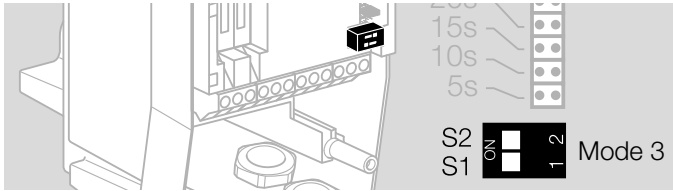

The first test is carried out before burner run (as with Mode 1):

The tightness test starts with incoming thermostat/start-up signal 9 . If the valves are tight, the LEDs A1O and A2O are green. Once the safety interlock input signal A is active, the OK enable signal is forwarded to the automatic burner control unit, see page 24 (Test instant for Mode 1: testing before burner run).

The second test is carried out after burner run (as with Mode 2):

The tightness test after burner run starts when the thermostat/start-up signal 9 drops, see page 25 (Test instant for Mode 2: testing after burner run).

3.1.8 Measurement time t_M for TC 1, TC 2, TC 3

The sensitivity of the tightness control TC can be adjusted by adapting the measurement time t_M for each individual system. The longer the measurement time t_M , the greater the sensitivity of the tightness control. The longer the measurement time, the smaller the leakage rate at which a safety shut-down/fault lock-out is triggered.

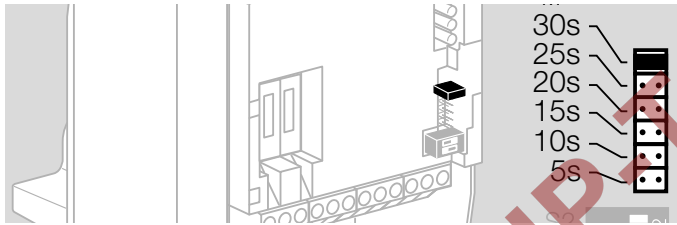

The measurement time can be set with a jumper to be between 5 s and max. 30 s.

30 s = factory setting

Without jumper: no function. The ϕ LED is permanently red.

The required measurement time t_M is calculated from:

$Q_{max.}$ = max. flow rate [m^3/h]

Q_L = leakage rate [l/h] = $Q_{max.}$ [m^3/h] \times 0.1%, see page 35 (Leakage rate Q_L)

p_u = inlet pressure [$mbar$]

V_P = test volume [l], see page 34 (Test volume V_P for TC 1, TC 2, TC 3, TC 4)

Converting units, see www.adlatus.org.

Measurement time t_M

$$t_M [s] = \frac{2.5 \times p_u [mbar] \times V_P [l]}{Q_L [l/h]}$$

For all combination controls CG, the measurement time t_M for TC 1C is 5 s.

Test period t_p

The entire test period is calculated from the measurement time t_M for both valves and the fixed opening time t_L of both valves.

$$t_p [s] = 2 \times t_L + 2 \times t_M$$

3.1.9 Calculation example for t_M

See Calculating measurement time t_M of tightness controls TC 1, TC 2, TC 3.

3.2.2 Test procedure TC 4

The TEST starts with the waiting time t_W . Once the waiting time has elapsed, the tightness control TC checks the pressure between the inlet valve V1 and the outlet valve V2:

Depending on the pressure between the valves p_z , the tightness control TC carries out a check using test procedure **A** or **B**:

If pressure $p_z > p_u/2$, program A starts.

If pressure $p_z < p_u/2$, program B starts, see page 30 (Test procedure B).

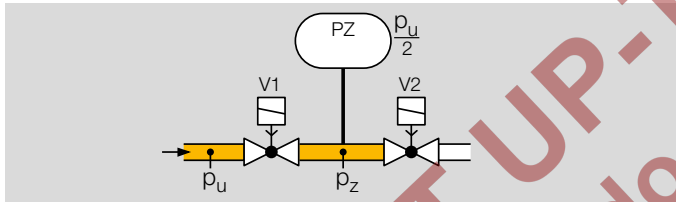

Test procedure A

If pressure p_z is greater than half the inlet pressure $p_u/2$, valve V2 is tight. Valve V2 is opened for the opening time $t_L = 2$ s. V2 closes again.

During the measurement time t_M , the tightness control checks the pressure p_z between the valves.

If pressure p_z is greater than half the inlet pressure $p_u/2$, valve V1 is leaking.

If pressure p_z is less than half the inlet pressure $p_u/2$, valve V1 is tight.

The tightness test can only be performed if the pressure downstream of V2 is around atmospheric pressure.

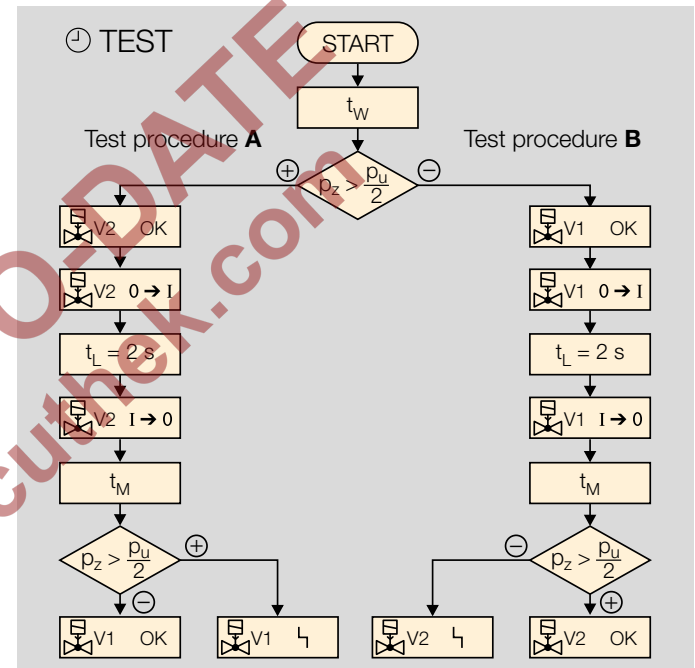

Test procedure B

If pressure $p_z < p_u/2$, valve V1 is tight. Valve V1 is opened for the opening time $t_L = 2$ s. V1 closes again. During the measurement time t_M , the tightness control checks the pressure p_z between the valves.

If pressure $p_z < p_u/2$, valve V2 is leaking.

If pressure $p_z > p_u/2$, valve V2 is tight.

The tightness test can only be performed if the pressure downstream of V2 is around atmospheric pressure and the volume downstream of V2 is at least 5 x higher than the volume between the valves.

The tightness control TC runs program **A** or **B** depending on the initial situation. Both valves are checked for tightness respectively, but only one valve is opened at a time.

During the test, the TC also checks their fail-safe operation.

After a brief power failure during the tightness test or operation, the TC restarts automatically.

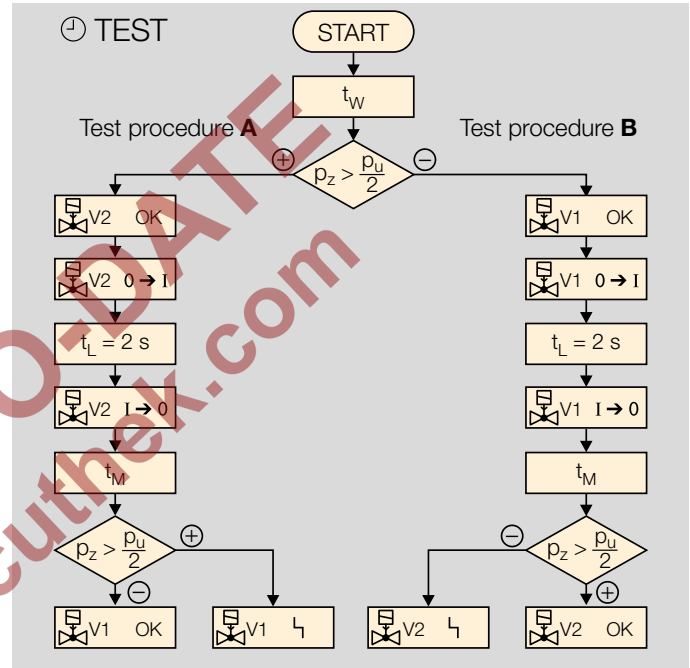

3.2.3 TC 4 test instant

A jumper (on the left in the picture) is used to determine whether the tightness of the gas solenoid valves is to be checked before or after burner run.

The test period t_p is set using the second jumper (on the right in the picture), see page 33 (Test period t_P for TC 4).

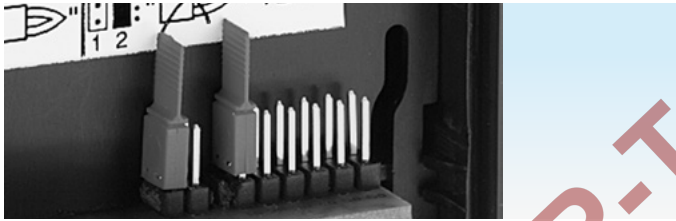

3.2.4 Test instant for Mode 1: testing before burner run

Mode 1 = factory setting.

Mains voltage L1 is switched on. The tightness test starts with incoming thermostat/start-up signal θ . If the valves are tight, the green OK LED lights up. The OK enable signal is forwarded to the automatic burner control unit.

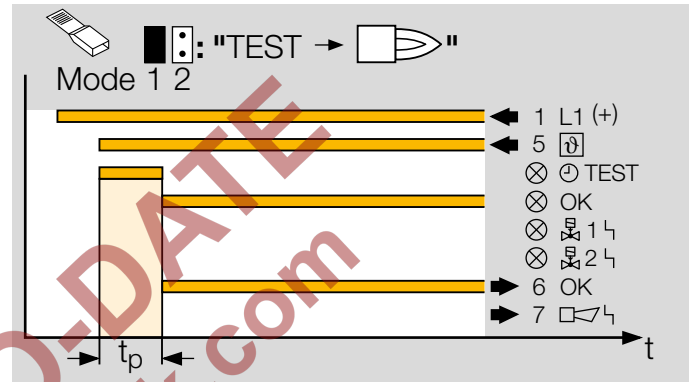

If the tightness control TC detects a leak on one of the two valves, the red LED lights up for a fault on valve V1 $\overline{1}$ or valve V2 $\overline{2}$. A fault is signalled externally \square , e.g. by switching on a buzzer or a warning light.

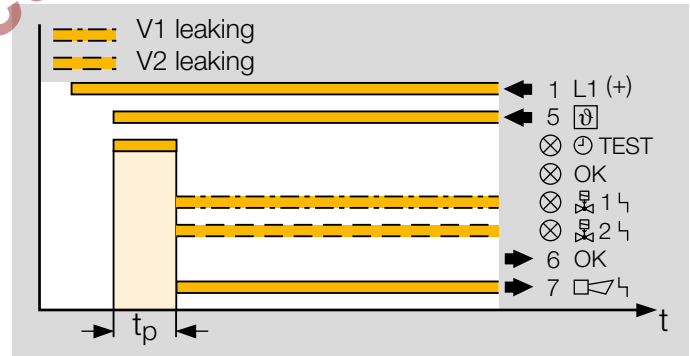

3.2.5 Test instant for Mode 2: testing after burner run

If the jumper is set to Mode 2, the tightness test after burner run begins as soon as the burner is switched off.

To ensure that the valves are checked for tightness once before starting up the system, the tightness test runs when the mains voltage (L1) is applied. If the valves are tight, the green OK LED lights up. The OK enable signal is not forwarded to the automatic burner control unit until the thermostat/start-up signal ϑ has been applied.

The tightness test after burner run starts when the thermostat/start-up signal ϑ drops. The OK enable signal is not forwarded to the automatic burner control unit again until the thermostat/start-up signal ϑ has been re-applied.

If the tightness control TC detects a leak on one of the two valves, the red LED lights up for a fault on valve V1 or valve V2. A fault is signalled externally, e.g. by switching on a buzzer or a warning light.

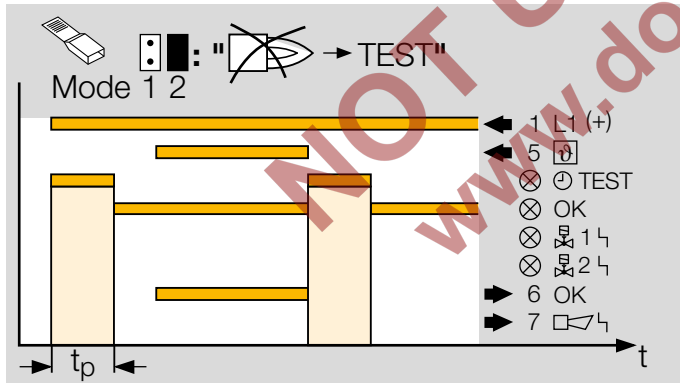
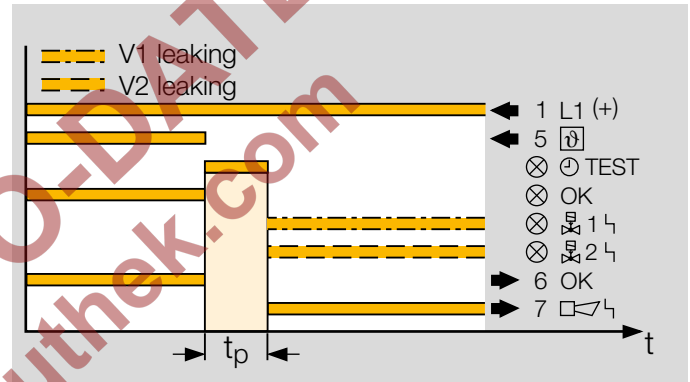

3.2.6 Test period t_p for TC 4

The sensitivity of the tightness control TC can be adjusted by adapting the test period t_p for each individual system. The longer the test period t_p , the greater the sensitivity of the TC. The longer the test period, the smaller the leakage rate at which a safety shut-down/fault lock-out is triggered.

The test period is set using the second jumper (on the right in the picture).

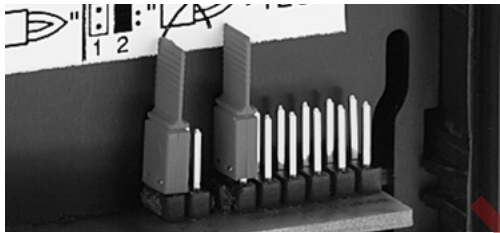

The test period t_p can be adjusted in intervals:

TC 410-1: 10 s to max. 60 s,

10 s = factory setting,

60 s = without jumper.

TC 410-10: 100 s to max. 600 s,

100 s = factory setting,

600 s = without jumper.

The required test period t_p is calculated from:

$Q_{\max.}$ = max. flow rate [m^3/h]

Q_L = leakage rate [l/h] = $Q_{\max.}$ [m^3/h] \times 0.1%,

see page 35 (Leakage rate Q_L)

p_u = inlet pressure [mbar]

V_p = test volume [l], see page 34 (Test volume V_P for TC 1, TC 2, TC 3, TC 4)

Converting units, see www.adlatus.org.

$$t_p [\text{s}] = 4 \times \left(\frac{p_u [\text{mbar}] \times V_p [\text{l}]}{Q_L [\text{l}/\text{h}]} + 1 \text{ s} \right)$$

3.2.7 Calculation example for t_p

See Calculating test period t_p of tightness control TC 4.

3.3 Test volume V_P for TC 1, TC 2, TC 3, TC 4

Test volume V_P is calculated from the valve volume V_V , added to the volume of the pipe V_R for each additional metre in length L .

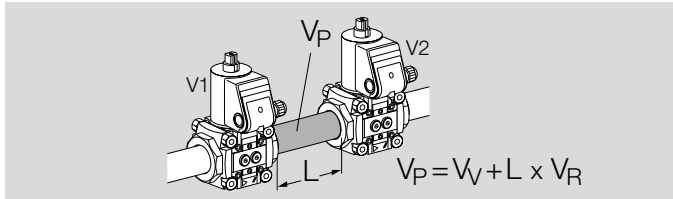

The tightness control TC requires a minimum start rate in order to carry out tightness tests on slow opening valves, see page 38 (Project planning information).

Valves	Valve volume V_V [l]	Nominal size DN	Pipe volume V_R [l/m]
VG 10	0.01	10	0.1
VG 15	0.07	15	0.2
VG 20	0.12	20	0.3
VG 25	0.2	25	0.5
VG 40/VK 40	0.7	40	1.3
VG 50/VK 50	1.2	50	2
VG 65/VK 65	2	65	3.3
VG 80/VK 80	4	80	5
VG 100/VK 100	8.3	100	7.9
VK 125	13.6	125	12.3
VK 150	20	150	17.7
VK 200	42	200	31.4
VK 250	66	250	49
VAS 1	0.08		
VAS 2	0.32		
VAS 3	0.68		
VAS 6	1.37		
VAS 7	2.04		
VAS 8	3.34		
VAS 9	5.41		
VCS 1	0.05		
VCS 2	0.18		
VCS 3	0.39		
VCS 6	1.11		
VCS 7	1.40		
VCS 8	2.82		
VCS 9	4.34		

3.4 Leakage rate Q_L

If no leakage rate is specified, we recommend the max. possible test period/measurement time is set.

It is possible to check a specific leakage rate Q_L using the TC. Within the scope of the European Union, the maximum leakage rate Q_L is 0.1% of the maximum flow rate $Q_{(n) \max.}$ [m^3/h].

$$\text{Leakage rate } Q_L \text{ [l/h]} = \frac{Q_{(n) \max.} \text{ [m}^3\text{/h]} \times 1000}{1000}$$

If a small leakage rate Q_L is to be detected, a long test period/measurement time must be set.

NOT UP-TO-DATE
www.docuthek.com

3.5 Animation

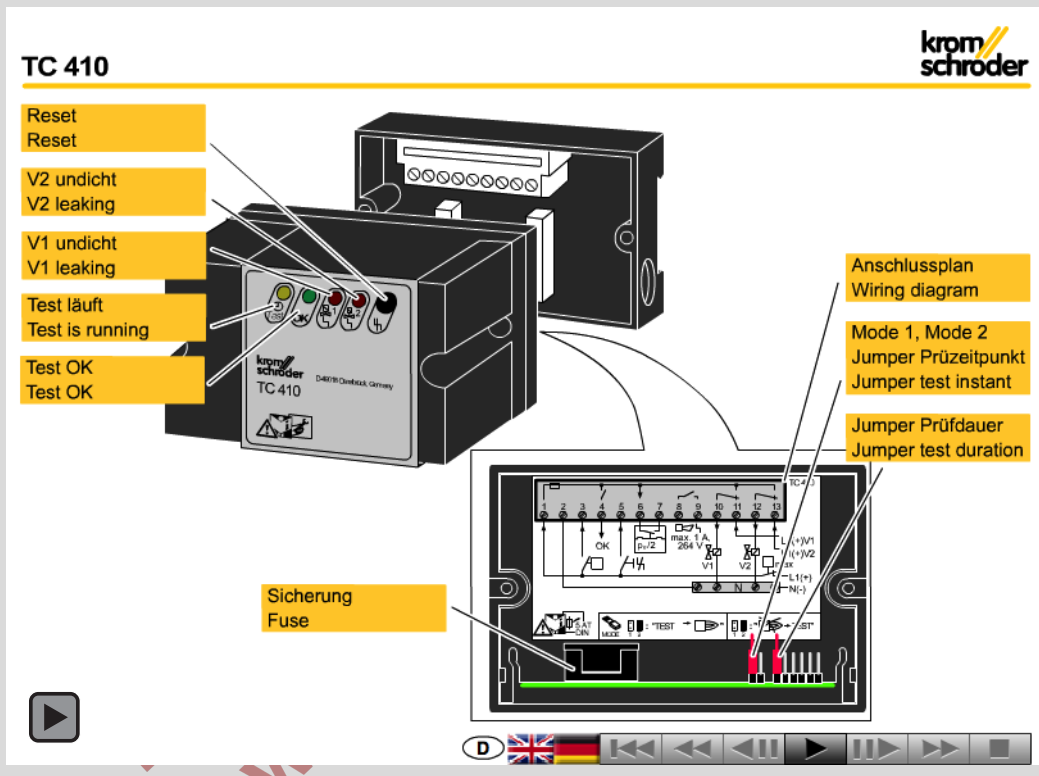

The interactive animation shows the function of the tightness control TC 4.

Click on the picture. The animation can be controlled using the control bar at the bottom of the window (as on a DVD player).

To play the animation, you will need Adobe Reader 7 or a newer version. If you do not have Adobe Reader on your system, you can download it from the Internet.

If the animation does not start to play, you can download it from the document library (Docuthek) as an independent application.

4 Selection

4.1 TC 1, TC 2, TC 3

4.1.1 Selection table

	R	N	05	W/W	Q/Q	K/K	W/K	Q/K
TC 1V			●	●	●	●	●	●
TC 1C			●	●	●	●	●	●
TC 2	●	●	●	●	●	●	●	●
TC 3	●	●	●	●	●	●	●	●

● = standard, ○ = available

Order example

TC 1V05W/K

4.1.2 Type code

Code	Description
TC	Tightness control
1V	For attachment to valVario
1C	For attachment to CG
2	For quick opening individual valves
3	For quick or slow opening valves
R	With Rp internal thread
N	With NPT internal thread
05	p _u max. 500 mbar
W	Mains voltage: 230 V AC, 50/60 Hz
Q	120 V AC, 50/60 Hz
K	24 V DC
/W	Control voltage: 230 V AC, 50/60 Hz
/Q	120 V AC, 50/60 Hz
/K	24 V DC

4.2 TC 4

4.2.1 Selection table

	-1	-10	T	N	K
TC 410	●	●	●	●	●

● = standard, ○ = available

Order example

TC 410-10T

4.2.2 Type code

Code	Description
TC	Tightness control
4	In control cabinet
1	Testing before or after burner run
0	External pressure switch required
-1	Test period: 10 – 60 s
-10	100 – 600 s
T	Mains voltage: 220/240 V AC, 50/60 Hz
N	110/120 V AC, 50/60 Hz
K	24 V DC=

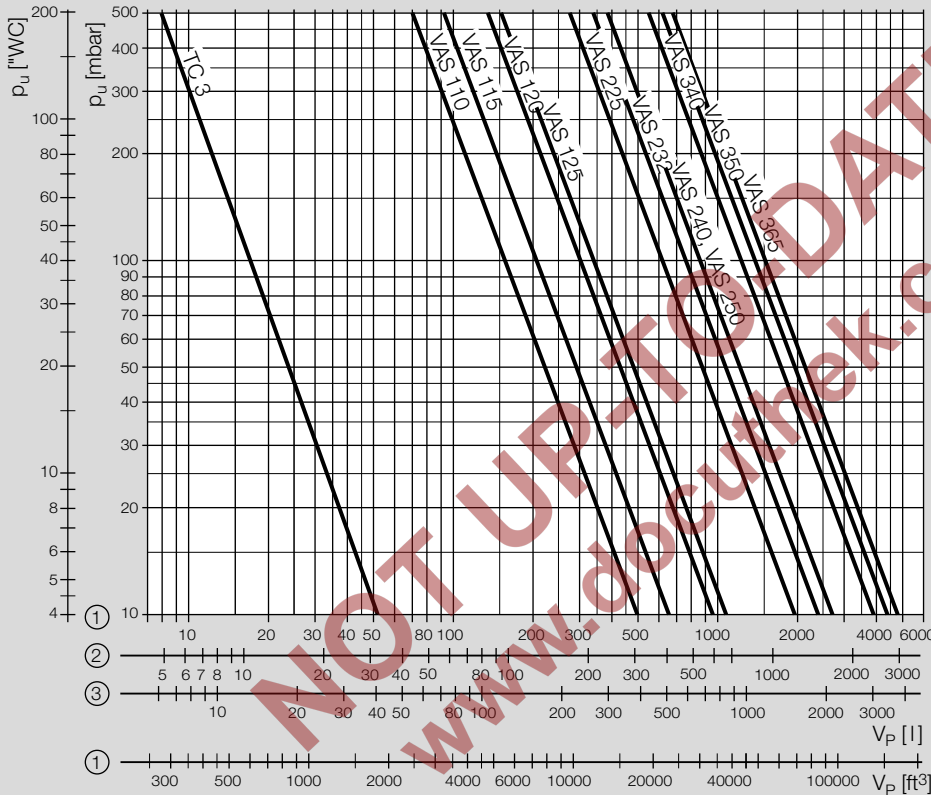

5 Project planning information

On slow opening valves without start rate or pneumatically operated valves, the test volume can be supplied or discharged via auxiliary valves, if discharge into the furnace chamber is impossible for process reasons.

5.1 Selecting the auxiliary valves

Example:

$V_P = 32.45$ l (8.44 gal),

$p_u = 50$ mbar (19.5 °WC).

Selecting auxiliary valve V1:

selected \Rightarrow VAS 110.

The valve is sufficiently large to vent the pipe between the valves.

① = natural gas $\rho = 0.8$ kg/m³ (0.05 lbs/ft³)

② = propane $\rho = 2.01$ kg/m³ (0.13 lbs/ft³)

③ = air $\rho = 1.29$ kg/m³ (0.08 lbs/ft³)

5.2 Start rate

The tightness control TC requires a minimum start rate in order to carry out tightness tests on slow opening valves:

up to 5 l (1.3 gal) test volume $V_P =$

5% of maximum flow rate $Q_{max.}$,

up to 12 l (3.12 gal) test volume $V_P =$

10% of maximum flow rate $Q_{max.}$

5.3 Installation

Installation of TC 1, TC 2, TC 3 in the vertical or horizontal position, housing cover/indicators must not point upwards or downwards. The electrical connection should preferably be pointing downwards or towards the outlet.

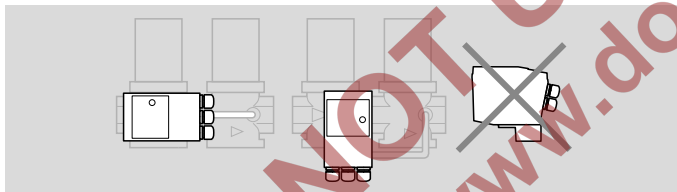

TC 4 installation position: any.

Avoid condensation in the system.

Do not store or install the unit in the open air.

The tightness control TC must not be in contact with masonry, minimum distance 20 mm (0.78 inches).

5.3.1 TC 1V for solenoid valves for gas VAS, VCx

The valve actuator cannot be rotated on gas solenoid valves with a proof of closure switch VCx..S or VCx..G.

When using a valve/pressure regulator combination VCG/VCV/VCH, the pressure regulator must be activated with air during the entire test period t_p . This ensures that the space between the valves can be filled and vented.

A TC and a bypass/pilot gas valve cannot be fitted together on the same attachment side of the VAS or VCx.

5.3.2 TC 1C for combination controls CG

An adapter plate is supplied for mounting the TC 1C to a combination control CG. The connections for p_u and p_z are marked on the adapter plate.

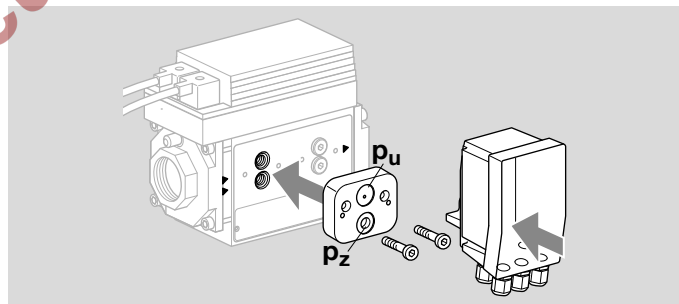

5.3.3 TC 2

An adapter plate is supplied for mounting the TC 2 to a gas solenoid valve.

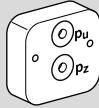

We recommend using Ermeto screw couplings to attach the adapter plate to the gas solenoid valve.

The connections for p_u and p_z are marked on the adapter plate.

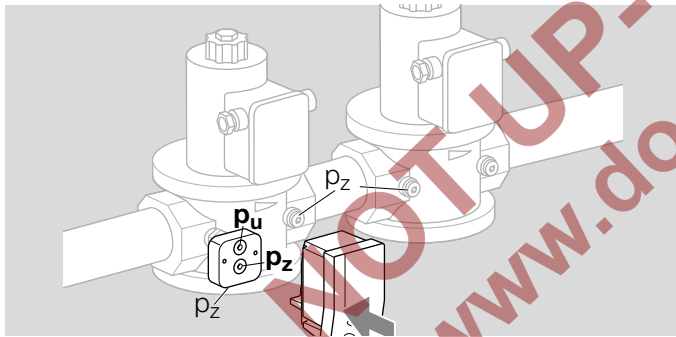

5.3.4 TC 3

Connect the TC to the inlet pressure connection p_u , the intermediate pressure connection p_z and the outlet pressure connection p_d of the inlet valve. Use a 12 x 1.5 or 8 x 1 pipe for the pipe connections.

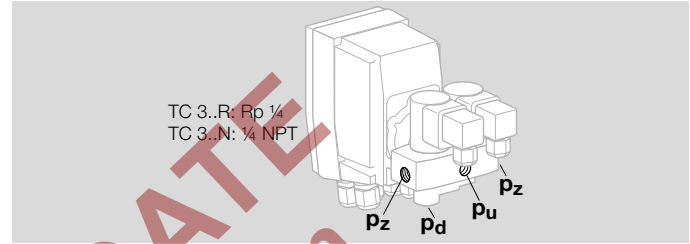

5.3.5 TC 4

On the TC 4, the external pressure switch is mounted on the interspace between the valves to be monitored. The TC can be installed separately from the valves. For installation in the control cabinet housing, for example, the lower section can be secured with screws or mounted on a DIN rail.

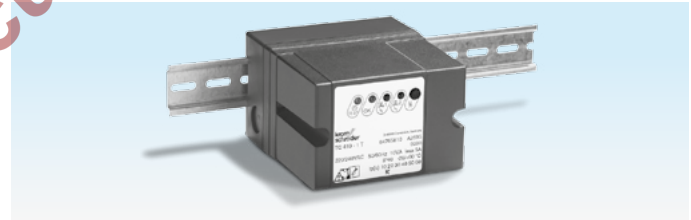

Snap attachment for DIN rail of 35 mm (1.36 inch) in width.

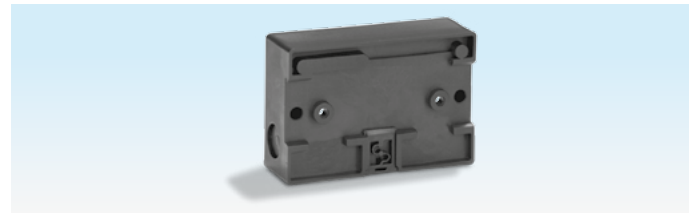

5.4 Electrical connection of TC 1, TC 2

For the electrical connection of the TC to valves with a plug, a socket can be supplied as an accessory, see page 42 (Accessories).

5.5 Determining the relief line size

The nominal diameter of the relief line should be large enough to discharge the test volume V_p . The cross-section of the relief line should be 5 times the sum of the cross-sections of all pipes whose volume is intended to be discharged via the relief line.

NOT UP-TO-DATE
www.docuthek.com

6 Accessories

6.1 Socket

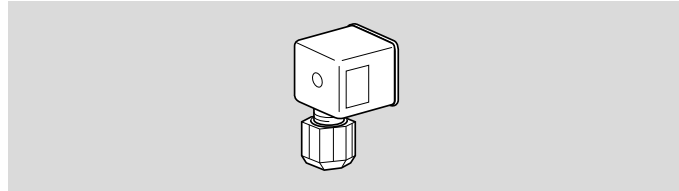

Standard socket, 3 pins + PE, black/B:
Order No. 74916715

6.2 Valve connection cable

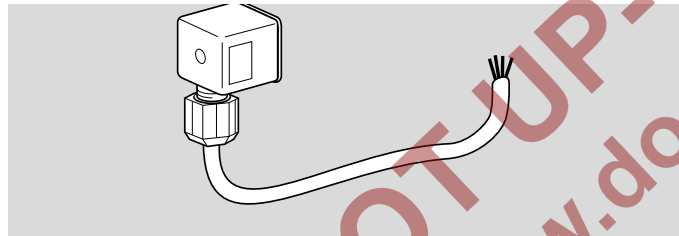

Standard socket, 3 pins + PE, black,
4-core electrical cable, cable length 0.45 m, Order
No. 74960689

6.3 External pressure switch for TC 4



Gas pressure switches DG, DG..C for monitoring the pressure between the valves to be checked.

For inlet pressures of 0.5 to 500 mbar (0.2 to 195 "WC).
The switching differential may not exceed $\pm 10\%$ of the set switching pressure

(see Technical Information bulletin Pressure switch for gas DG, DG..C at www.docuthek.com).

Adjustment

The external pressure switch is set to half the inlet pressure $p_u/2$ (only NO contact required) in order to check both valves with equal sensitivity.

Example: $p_u = 100$ mbar (39 "WC),
set switching pressure $p_u/2 = 50$ mbar (19.5 "WC).

7 Technical data

7.1 TC 1, TC 2, TC 3

Electrical data

Mains voltage and control voltage:

120 V AC, -15/+10%, 50/60 Hz,
230 V AC, -15/+10%, 50/60 Hz,
24 V DC, $\pm 20\%$.

Power consumption (all LEDs green):

5.5 W at 120 V AC and 230 V AC,
2 W at 24 V DC,

TC 3: plus 8 VA for an auxiliary valve.

Fine-wire fuse: 5 A, slow-acting, H, 250 V, pursuant to IEC 60127-2/5,

F1: protection of valve outputs (terminals 15 and 16), fault signal (terminal 12) and supply of the control inputs (terminals 2, 7 and 8).

F2: protection of safety interlock/controller enable signal (terminal 6).

The input current at terminal 1 must not exceed 5 A.

Max. load current (terminal 6) for safety interlock/controller enable and valve outputs (terminals 15 and 16):
at 230/120 V AC mains voltage, max. 3 A resistive load;
at 24 V DC mains voltage, max. 5 A resistive load.

External fault signal (terminal 12):

fault output at 120 V AC/230 V AC/24 V DC mains and control voltage: max. 5 A,

fault output at 120 V AC/230 V AC mains voltage,
24 V DC control voltage: max. 100 mA.

TC switching cycles: 250,000 pursuant to EN 13611.

Reset: using a button on the device or by remote reset.

Environment

Gas type: natural gas, town gas, LPG (gaseous), biogas (max. 0.1 %-by-vol. H₂S) and air.

The gas must be clean and dry in all temperature conditions and must not contain condensate.

Inlet pressure p_{in} : 10 to 500 mbar (3.9 to 195 "WC).

Measurement time t_M : 5 to 30 s, adjustable.

Set at the factory to 30 s.

Medium and ambient temperatures:
-20 to +60°C (-4 to +140°F).

No condensation permitted.

Long-term use in the upper ambient temperature range accelerates the ageing of the elastomer materials and reduces the service life.

Storage temperature: -20 to +40°C (-4 to +104°F).

Mechanical data

Length of connection cable:

at 230 V AC/120 V AC: any,

at 24 V DC (supply connected to PE):

max. 10 m permitted,

at 24 V DC (supply not connected to PE):

any.

Cable cross-section: min. 0.75 mm² (AWG 19),

max. 2.5 mm² (AWG 14).

5 cable glands: M16 x 1.5.

Valve opening time: 3 s.

Housing made of impact-resistant plastic.

Connectors: aluminium.

Enclosure: IP 65.

Weight:

TC 1V: 215 g (0.47 lbs),

TC 1C with adapter: 260 g (0.57 lbs),

TC 2 with adapter: 260 g (0.57 lbs),

TC 3: 420 g (0.92 lbs).

7.2 TC 4

Electrical data

Mains voltage:

110/120 V AC, -15/+10%, 50/60 Hz,

220/240 V AC, -15/+10%, 50/60 Hz,

24 V DC, ±20%.

Power consumption:

10 VA for 110/120 V AC and 220/240 V AC,

1.2 W for 24 V DC.

Fusing: fine-wire fuse 5 A, slow-acting, H pursuant to IEC 127, also protects the valve outputs and external operating signal.

Switching current for valves/enable output: max. 5 A.

External operating signal: with mains voltage, max. 5 A resistive load (UL listed: 5 A for 120 V), max. 2 A at $\cos \varphi = 0.35$ (pilot duty).

Fault output: dry contact (not internally fused), max. 1 A for 220/240 V (high voltage: 264 V), max. 2 A for 120 V.

Reset: using a button on the device.

Remote reset: by applying control voltage (terminal 5).

Technical data

Environment

Gas type and inlet pressure p_U :
dependent on external pressure switch.

The pressure switch is set to half the inlet pressure $p_U/2$.

The switching differential may not exceed $\pm 10\%$ of the set switching pressure, see page 42 (External pressure switch for TC 4).

Test period t_p :

TC 410-1: 10 to 60 s, adjustable.

Set at the factory to 10 s.

TC 410-10: 100 to 600 s, adjustable.

Set at the factory to 100 s.

Ambient temperature: -15 to $+60^\circ\text{C}$
(5 to 140°F), no condensation permitted.

Storage temperature: -15 to $+40^\circ\text{C}$ (5 to 104°F).

Mechanical data

Enclosure: IP 40.

5 knock-out holes for M16 plastic cable glands.

Screw terminals: 2.5 mm^2 (AWG 14).

Housing made of impact-resistant plastic.

Weight: approx. 400 g (0.88 lbs).

7.3 Indicators and operating controls

TC 1, TC 2, TC 3

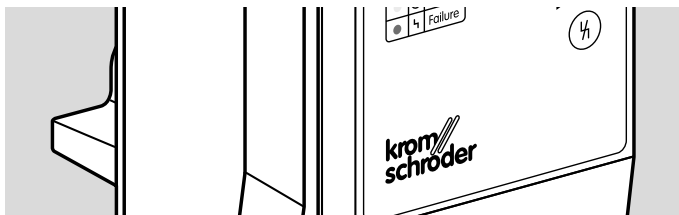

Power = power supply

⏻ = operating signal

⚙️¹ = valve 1

⚙️² = valve 2

⌛ = reset button

TC 4

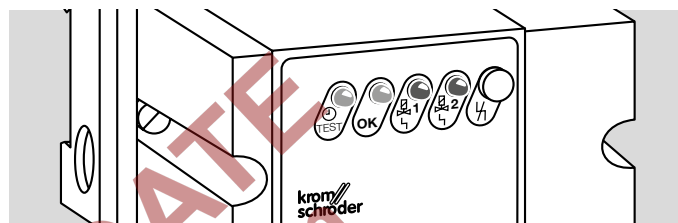



⦿ TEST = TEST phase (yellow)











⏻ = operating signal (green)

⚙️¹ ⌛ = fault valve 1 (red)

⚙️² ⌛ = fault valve 2 (red)

⌛ = reset button

The LEDs can display messages using three colours (green, yellow, red) and permanent  or flashing light .

LED		Message/Operating status
Power	 green	Power supply OK
	 yellow	TC is ready for operation; safety interlock* input signal interrupted
	 green	TC is ready for operation; active safety interlock* input signal
	 green	V1 is tight
	 yellow	V1 is untested
	 yellow	Tightness test is running on V1
	 red	V1 is leaking
	 green	V2 is tight
	 yellow	V2 is untested
	 yellow	Tightness test is running on V2
	 red	V2 is leaking
All	yellow	Initialization

* see page 53 (Safety interlocks).

7.4 Dimensions

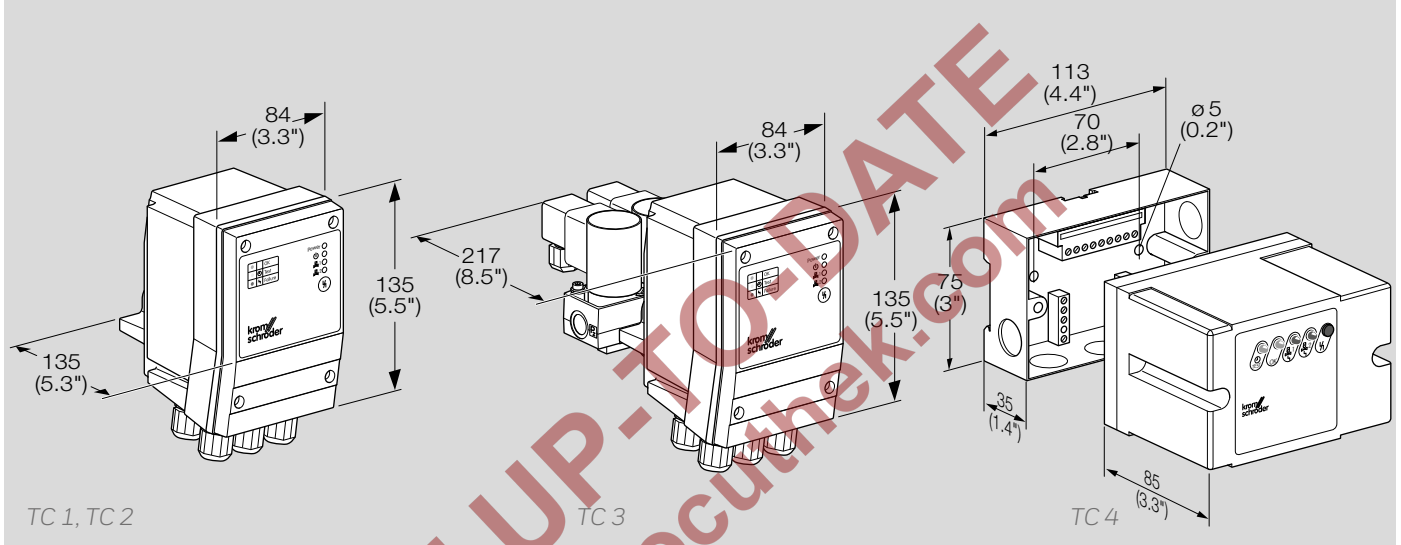

7.5 Converting units

see www.adlatus.org

7.6 Safety-specific characteristic values

For systems up to SIL 3 pursuant to EN 61508

Mains and control voltage: 120 V AC/230 V AC	
Diagnostic coverage DC	91.4%
Mean probability of dangerous failure PFH _D	17.3×10^{-9} 1/h

Mains voltage: 120 V AC/230 V AC, control voltage: 24 V DC	
Diagnostic coverage DC	91.3%
Mean probability of dangerous failure PFH _D	17.2×10^{-9} 1/h

Mains and control voltage: 24 V DC	
Diagnostic coverage DC	91.5%
Mean probability of dangerous failure PFH _D	17.5×10^{-9} 1/h

General	
Mean probability of dangerous failure PFH _D	Auxiliary valves with valve block on TC 3: 0.2×10^{-9} 1/h
Type of subsystem	Type B to EN 61508-2
Operating mode	High demand mode pursuant to EN 61508-4 Continuous operation (to EN 1643)
Mean time to dangerous failure MTTF _d	1/PFH _D
Safe failure fraction SFF	97.5%

Pursuant to EN ISO 13849-1, Table 4, TC 1, TC 2 and TC 3 can be used up to PL e.

Relationship between the Performance Level (PL) and the Safety Integrity Level (SIL)

PL	SIL
a	–
b	1
c	1
d	2
e	3

Max. service life under operating conditions:
10 years after date of production.

For a glossary of terms, see page 53 (Glossary).

For further information on SIL/PL, see www.k-sil.de

8 Safety information in accordance with EN 61508-2 for TC 1, TC 2, TC 3

8.1 General

Scope of application

Machinery Directive (2006/42/EC) with the applicable harmonized standards

As set out in “Industrial thermoprocessing equipment – Part 2: Safety requirements for combustion and fuel handling systems” (EN 746-2).

Aim

The TC 1, TC 2, TC 3 is a control unit pursuant to EN 60730-2-5, Section 6.3.103.

8.1.1 Type of action

The automatic action of the TC 1, TC 2, TC 3 corresponds to Type 2 pursuant to EN 60730-1, Section 1/5.

Operating mode

The TC 1, TC 2, TC 3 is capable of continuous operation and thus fulfils the characteristic of automatic action type 2.AD pursuant to EN 60730-2-5, Section 6.4.104.

Switching off the safety-relevant output signals: the safety-relevant output signals are switched off via relays. This is a shut-down with micro switch pursuant to EN 60730-1, Sections 6.4.3.2 and 6.9.2.

Fault lock-out

Non-volatile fault lock-out, action type 2.V pursuant to EN 60730-2-5, Section 6.4.101.

8.1.2 Other classifications

Load

The outputs of the TC are primarily designed for resistive loads with a power factor ≥ 0.95 .

Automatic cycles

The tightness control is designed for more than 250,000 automatic cycles.

Fault detection time

On demand

Software class

C (operates in a similar double-channel architecture with comparison)

8.1.3 Electrical data

Safety class

Safety class

Overvoltage category

Overvoltage category III (hard wiring/industrial application)

Pollution degree

TC 1, TC 2, TC 3: pollution degree 2 (\geq IP 65).

8.2 Interfaces

8.2.1 Electrical wiring

Attachment type X to EN 60730-1.

230 V AC, 120 V AC

Connection:

The TC 1, TC 2, TC 3 must be correctly phased in accordance with the connection diagrams.

24 V DC

Extra-low voltage (ELV):

If the TC 1, TC 2, TC 3 is supplied with ELV, at which Minus/-/GND are connected to PE, all connected cables must not be longer than 10 m.

If the TC 1, TC 2, TC 3 is supplied with ELV, at which Minus/-/GND are not connected to PE, all connected cables may be longer than 10 m.

Safety extra-low voltage (SELV):

If the TC 1, TC 2, TC 3 is supplied with SELV, all connected components must also fulfil the requirements of SELV.

Protected extra low voltage (PELV):

If the TC 1, TC 2, TC 3 is supplied with PELV, all connected cables must not be longer than 10 m.

8.2.2 Connection terminals

Supply and control signal terminals

Mains voltage = control voltage 24 V DC, 120 V AC or 230 V AC: power is supplied to the TC via connection terminals 1 (L1 (+)) and 3 (N (-)). Further terminal assignment, see connection diagrams.

120 V AC or 230 V AC mains voltage, 24 V DC control voltage: control voltage is supplied via connection terminals 8 (+) and 9 (-).

Terminals for automatic burner control unit and valves

See connection diagrams.

PE wire connection

5 PE terminals for forwarding. Connection to the system PE must be carried out/wired by the user.

8.2.3 Inputs

Safety interlocks (limits) Δ

Input voltage = mains voltage

Thermostat/start-up signal ϑ

Input voltage = control voltage

Reset/remote reset $\frac{1}{2}$

Input voltage = control voltage

8.2.4 Outputs

Safety interlock Δ /OK enable signal

at 230/120 V AC mains voltage, max. 3 A resistive load,
at 24 V DC mains voltage, max. 5 A resistive load.

Valve outputs V1 and V2

at 230/120 V AC mains voltage, max. 3 A resistive load,
at 24 V DC mains voltage, max. 5 A resistive load.

Fault signal \downarrow

at 24 V DC, 120 V AC or 230 V AC mains voltage and
control voltage:
max. 5 A resistive load,

at 120 V AC/230 V AC mains voltage and 24 V DC con-
trol voltage: max. 100 mA.

8.3 SIL and PL for TC 1, TC 2, TC 3

Safety function

The basic safety function of the TC 1, TC 2, TC 3 is to
check that automatic shut-off valves have closed effec-
tively by detecting leakage.

Classification

Class C regulating and control functions

Demand mode

High demand mode pursuant to IEC 61508-4

Hardware Fault Tolerance HFT

HFT: N = 0

SIL Safety Integrity Level/PL Performance Level

See page 48 (Safety-specific characteristic values).

9 Maintenance cycles

Tightness controls TC require little servicing. We recommend carrying out a function check once a year or twice a year in the case of biogas.

NOT UP-TO-DATE
www.docuthek.com

10 Glossary

10.1 Tightness control

The term “tightness control” is the product name of product group TC from Elster GmbH. Tightness control TC is a valve proving system (VPS).

10.2 Valve proving system VPS

System to check that automatic shut-off valves have closed effectively by detecting leakage. This system is frequently comprised of a program unit, a measuring device, valves and other functional equipment. Valve proving systems for gas burners and gas appliances pursuant to DIN EN 1643 determine whether an automatic shut-off valve has closed on the basis of the detected leakage rate.

see EN 1643

10.3 Safety interlocks

Linking of all the relevant safety control and switching equipment for the use of the application. The burner start enable signal is issued via the safety interlock output (terminal 6).

10.4 Diagnostic coverage DC

Measure of the effectiveness of diagnostics, which may be determined as the ratio between the failure rate of detected dangerous failures and the failure rate of total dangerous failures

NOTE: Diagnostic coverage can exist for the whole or parts of a safety-related system. For example, diagnostic coverage could exist for sensors and/or logic system and/or final elements. Unit: %

see EN ISO 13849-1

10.5 Operating mode

High demand mode or continuous mode

Operating mode, where the frequency of demands for operation made on a safety-related system is greater than one per year or greater than twice the proof-test frequency

see EN 61508-4

10.6 Hardware fault tolerance HFT

A hardware fault tolerance of N means that N + 1 is the minimum number of faults that could cause a loss of the safety function

see IEC 61508-2

10.7 Probability of dangerous failure PFH_D

Value describing the likelihood of dangerous failure per hour of a component for high demand mode or continuous mode. Unit: 1/h

see EN 13611/A2

10.8 Mean time to dangerous failure $MTTF_d$

Expectation of the mean time to dangerous failure

see EN ISO 13849-1

NOT UP-TO-DATE
www.docuthek.com

Feedback

Finally, we are offering you the opportunity to assess this “Technical Information (TI)” and to give us your opinion, so that we can improve our documents further and suit them to your needs.

Clarity

- Found information quickly
- Searched for a long time
- Didn't find information
- What is missing?
- No answer

Comprehension

- Coherent
- Too complicated
- No answer

Scope

- Too little
- Sufficient
- Too wide
- No answer



Use

- To get to know the product
- To choose a product
- Planning
- To look for information

Navigation

- I can find my way around
- I got “lost”
- No answer

My scope of functions

- Technical department
- Sales
- No answer

Remarks

Contact

Elster GmbH
Postfach 2809 · 49018 Osnabrück
Strothweg 1 · 49504 Lotte (Büren)
Germany

Tel +49 541 1214-0
Fax +49 541 1214-370
hts.lotte@honeywell.com
www.kromschroeder.com

The current addresses of our international agents are available on the Internet:
www.kromschroeder.de/Weltweit.20.0.html?&L=1

We reserve the right to make technical modifications in the interests of progress.
Copyright © 2017 Elster GmbH
All rights reserved.

Honeywell

krom
schroder