

Pressure switch for gas DG

Technical Information · GB
4 Edition 10.18

- Monitoring of gas and air pressures (positive, negative and differential pressures)
- Certified for systems up to SIL 3 and PL e
- With approved isolating amplifier for Zone 1 and 2 hazardous areas
- EU certified pursuant to EN 1854 and class “S”
- DG..S: special version available for NH₃ and O₂



Contents

Pressure switch for gas DG	1
Contents	2
1 Application	4
1.1 Use	5
1.1.1 DG.....	5
1.1.2 DG..T	5
1.2 Application examples	6
1.2.1 Low gas pressure monitoring	6
1.2.2 Differential pressure monitoring	6
1.2.3 Systems leak tightness check	6
1.2.4 Negative pressure monitoring.....	6
1.2.5 Air line with minimum pressure and flow monitoring ..	7
1.2.6 Low or high gas pressure protection device.....	7
2 Certification	8
2.1 Overview of product approvals	9
3 Function	10
3.1 Vent limiter.....	10
3.2 Positive pressure measurement	11
3.3 Negative pressure measurement.....	11
3.4 Differential pressure measurement	11
3.5 Connection diagram	13
3.5.1 Blue pilot lamp for 230 V AC or for 110/120 V AC ..	13
3.5.2 Pilot lamp with plug	13
3.5.3 Red/green pilot LED for 24 V DC/AC or for 110 V AC to 230 V AC	13
3.5.4 Pilot LED with plug	13
3.6 Wiring	14
3.7 DG in Zone 1 (21) and 2 (22) hazardous areas ...	15
3.8 DG on pipes with Zone 2 (22) explosive atmospheres.....	16
3.9 Animation	17
2 Selection	18
2.1 Selection table	18
2.2 Type code	19

2.2.1 DG	19
2.2.2 DG..T.....	20
3 Project planning information	21
3.1 Installation	21
3.2 Ports	22
3.2.1 DG	22
3.2.2 DG..T.....	23
3.3 Resetting pressure switches with manual reset ..	23
4 Accessories	24
4.1 Fastening set with screws, U-shape bracket	24
4.2 Connecting set.....	24
4.3 External adjustment.....	24
4.4 Pressure equalization element	25
4.5 Filter pad set	25
4.6 Test key PIA	25
4.7 Filter pad set	25
4.8 Tube set	26
4.9 Standard socket set	26
4.10 Standard coupler plug.....	26
4.11 Pilot lamp set, red or blue	26
4.12 LED set, red/green	26
4.13 Weather protection cover	27
5 Technical data	28
5.1 Adjusting range, switching hysteresis	30
5.1.1 DG	30
5.1.2 DG..T.....	31
5.2 Safety-specific characteristic values for DG	32
5.2.1 Determining the PFH _D value, the λ _D value and the MTTF _d value.....	33
5.2.2 Calculating the PFH _D and PFD _{avg}	33
5.3 Dimensions	34
5.4 Converting units	34
6 Maintenance cycles	34

7 Glossary	35
7.1 Diagnostic coverage DC	35
7.2 Mode of operation	35
7.3 Category	35
7.4 Common cause failure CCF	35
7.5 Fraction of undetected common cause failures β	35
7.6 B_{10d} value	35
7.7 T_{10d} value	35
7.8 Hardware fault tolerance HFT	36
7.9 Mean dangerous failure rate λ_D	36
7.10 Safe failure fraction SFF	36
7.11 Probability of dangerous failure PFH_D	36
7.12 Mean time to dangerous failure $MTTF_d$	36
7.13 Demand rate n_{op}	36
7.14 Average probability of dangerous failure on demand PFD_{avg}	36
Feedback	37
Contact	37

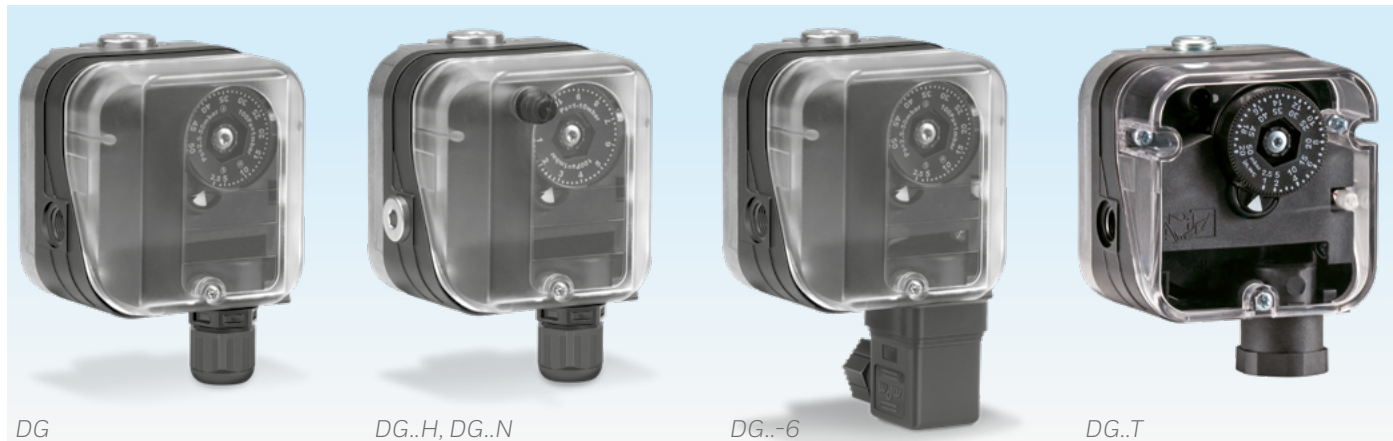

DG

Adjustable switching point

DG..H, DG..N

*Adjustable switching point.
Locks off once the switching
point is reached. Manual reset.*

DG..-6

*With fitted socket pursuant to
DIN EN 175301-803*

DG..T

*Hand wheel with "WC and
mbar scale.
1/2" NPT conduit for electrical
connection.*

1 Application

The gas pressure switch DG monitors extremely low pressure differentials and triggers switch-on, switch-off or switch-over operations if a set switching point is reached.

The switching point is adjustable via a hand wheel.

It monitors positive and negative gas pressures on various industrial gas and air appliances, such as boiler fan monitoring and differential pressure monitoring in firing, ventilation and air-conditioning systems.

Pressure switches with manual reset lock off after switching.

Pressure switches (DG..T) with UL, FM approval are fitted with a nozzle to limit the flow rate, see page 10 (Vent limiter).

The TÜV-tested special-design pressure switch is used as defined by VdTÜV Code of Practice "Druck 100/1" (Pressure 100/1) in firing installations for steam and hot-water generators in accordance with TRD 604, Para. 3.6.4, as well as class "S" for DG..B, DG..U and DG..I pursuant to EN 1854.

1.1 Use

1.1.1 DG

Code	Hand wheel setting/Switching properties	Positive pressure	Negative pressure	Electrical connection
DG..B	Hand wheel set to rising pressure/ DG switches with rising and falling pressure	Gas, air, flue gas or biogas	–	Screw terminals and M16 cable gland or plug with socket
DG..U	Hand wheel set to rising pressure/ DG switches with rising and falling pressure	Gas, air, flue gas or biogas	Air, flue gas	
DG..BN	Hand wheel set to falling pressure/ DG switches with rising and falling pressure	Gas, air, flue gas or biogas	–	
DG..UN	Hand wheel set to falling pressure/ DG switches with rising and falling pressure	Gas, air, flue gas or biogas	Air, flue gas	
DG..I	Hand wheel set to rising pressure/ DG switches with rising and falling pressure	Gas, air, flue gas	Gas, air, flue gas or biogas	
DG..S	Hand wheel set to rising pressure/ DG switches with rising and falling pressure	NH ₃ , O ₂ , air	–	
DG..H	Hand wheel set to rising pressure/ DG switches with rising pressure and locks off	Gas, air, flue gas or biogas	Air, flue gas	
DG..N	Hand wheel set to falling pressure/ DG switches with falling pressure and locks off	Gas, air, flue gas or biogas	Air, flue gas	

1.1.2 DG..T

Code	Hand wheel setting/Switching properties	Positive pressure	Negative pressure	Electrical connection
DG..T	Hand wheel set to rising pressure/ DG switches with rising and falling pressure	Gas, air, flue gas or biogas	Air, flue gas	Screw terminals and M16 cable gland or screw terminals and 1/2" NPT conduit or plug with socket
DG..FT	Hand wheel set to falling pressure/ DG switches with rising and falling pressure	Gas, air, flue gas or biogas	Air, flue gas	
DG..HT	Hand wheel set to rising pressure/ DG switches with rising pressure and locks off	Gas, air, flue gas or biogas	Air, flue gas	
DG..NT	Hand wheel set to falling pressure/ DG switches with falling pressure and locks off	Gas, air, flue gas or biogas	Air, flue gas	
DG..ST	Hand wheel set to rising pressure/ DG switches with rising and falling pressure	NH ₃ , O ₂ , air	–	

1.2 Application examples

1.2.1 Low gas pressure monitoring

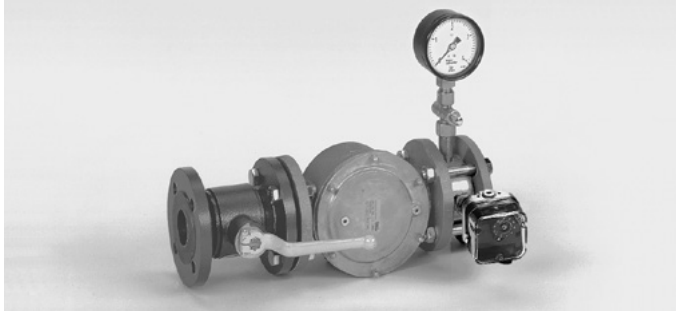

For monitoring the minimum gas inlet pressure

1.2.2 Differential pressure monitoring

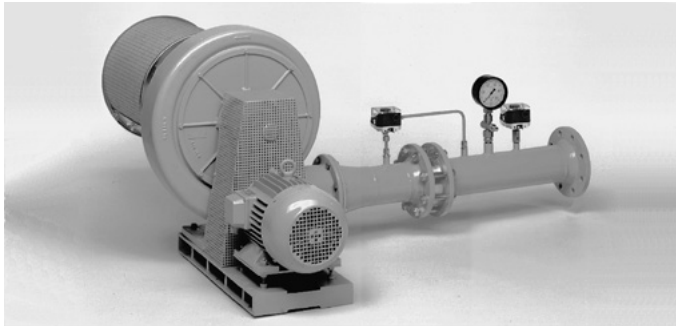

Differential pressure switch for monitoring air filters

1.2.3 Systems leak tightness check

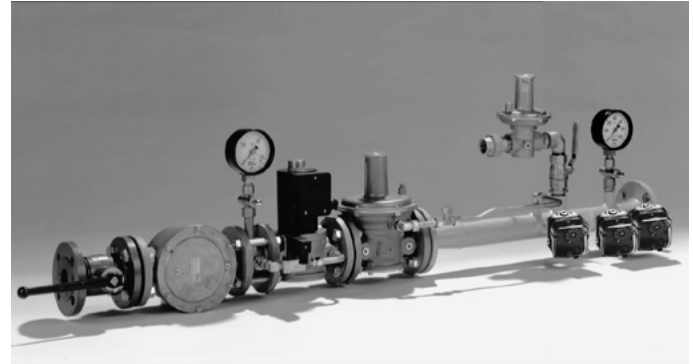

Electronic safety shut-off valve SAV with closed position check of downstream devices

1.2.4 Negative pressure monitoring



Monitoring the negative pressure ensures the correct positioning of the components during fully automatic assembly of gas meters.

1.2.5 Airline with minimum pressure and flow monitoring

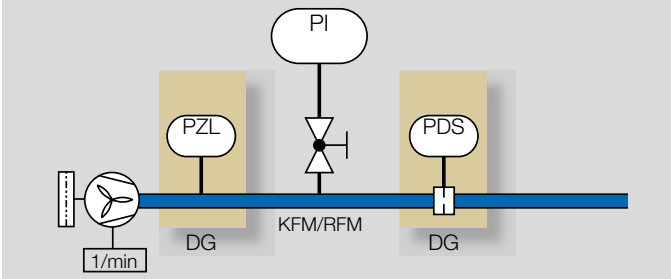

The air flow generated by the fan may be monitored as follows:

The static pressure is monitored by pressure switch DG (PZL) as long as it can be demonstrated that the display consequently shows an adequate and secured flow of air, or the pressure switch DG (PDS) controls the flow of air via the differential pressure on the orifice.

If there is no air pressure supplied or if there is no differential pressure on the orifice, the system will be blocked.

1.2.6 Low or high gas pressure protection device

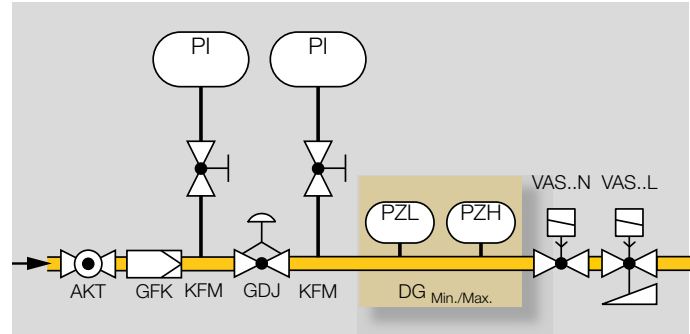

If the pressure is either too low or too high, the min./max. pressure switch DG (PZL/PZH) switches in order to avoid start-up or to initiate a safety shut-down.

2 Certification

Certificates – see Docuthek

Certified to SIL and PL*



For systems up to SIL 3 pursuant to EN 61508 and PL e pursuant to ISO 13849

EU certified*



- 2014/35/EU (LVD) – Low Voltage Directive
- 2014/30/EU (EMC) – Electromagnetic Compatibility Directive
- (EU) 2016/426 (GAR) – Gas Appliances Regulation
- EN 13611:2015+AC:2016
- EN 1854:2010, class S

AGA approved*



Australian Gas Association, Approval No.: 5484
http://www.aga.asn.au/product_directory

Eurasian Customs Union*



The product DG meets the technical specifications of the Eurasian Customs Union.

DG..T: FM approved*



Factory Mutual Research Class: 3510 Flow and pressure safety switches. Designed for applications pursuant to NFPA 85 and NFPA 86. www.approvalguide.com

DG..T: UL approved*

USA and Canada











UL 353 Limit control.

Underwriters Laboratories – www.ul.com → Tools (at the bottom of the page) → Online Certifications Directory

* Approval does not apply to DG..S. DG..S complies with the requirements of the Low Voltage Directive (2006/95/EC).

2.1 Overview of product approvals

		DG..B, DG..U, DG..H, DG..N, DG..I	DG..T, DG..HT, DG..NT	DG..S
		●	-	-
		●	-	●
		●	-	-
		●	-	-
		●	-	-
		-	●	-
		-	●	

3 Function

The pressure switch switches in the event of increasing or decreasing pressure. Once the set switching point is reached, a micro switch is activated in the DG which is designed as a change-over contact.

The switching pressure is adjusted using a hand wheel.

Pressure switches which lock off after switching can only be unlocked with a manual reset, see page 23 (Resetting pressure switches with manual reset).

DG

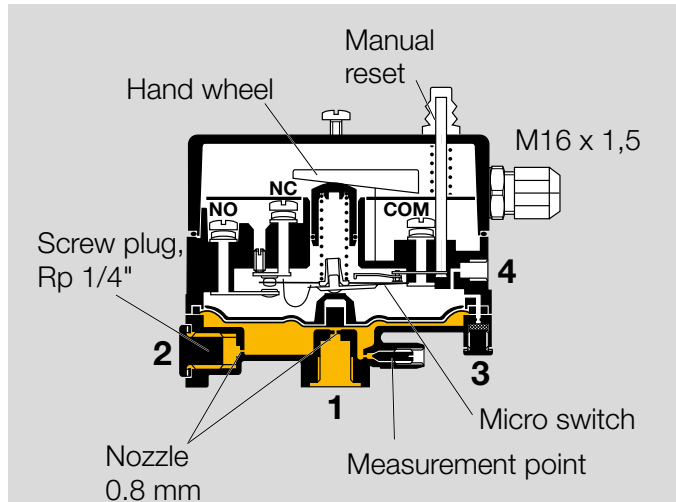

DG..T

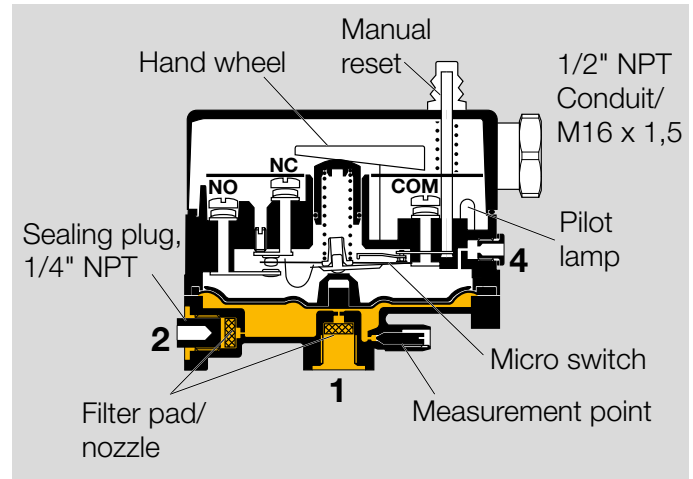

3.1 Vent limiter

The flow on pressure switches DG 6..T to DG 500..T is limited by the nozzle. In the event of a diaphragm tear, the escape of gas is limited to less than 1.0 CFH of natural gas, see max. inlet pressure, page 31 (DG..T), Technical data.

3.2 Positive pressure measurement

Positive pressure measurement is designed, for example, for checking the fan function or measuring the min./max. gas pressure.

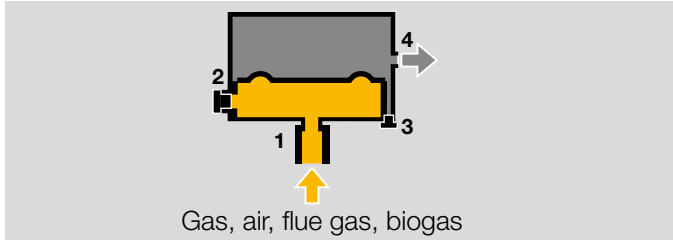

The positive pressure is measured in the lower diaphragm chamber, port **1** (or **2**). The upper diaphragm chamber is ventilated via port **4** (or **3**).

3.3 Negative pressure measurement

Negative pressure measurement (air, flue gas) is designed, for example, for monitoring a suction pressure blower.

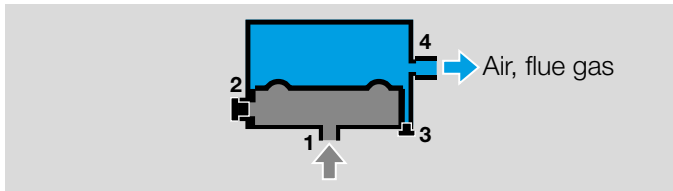

The negative pressure is measured in the upper diaphragm chamber, port **4** (or **3**). The lower diaphragm chamber is ventilated via port **1** (or **2**).

In the case of DG..I, the negative pressure (gas, air, flue gas or biogas) is measured in the lower diaphragm chamber, port **1** or **2**. The upper diaphragm chamber is ventilated via port **4** or **3**.

3.4 Differential pressure measurement

Differential pressure measurement is designed, for instance, for safeguarding an air flow rate or for monitoring filters and fans.

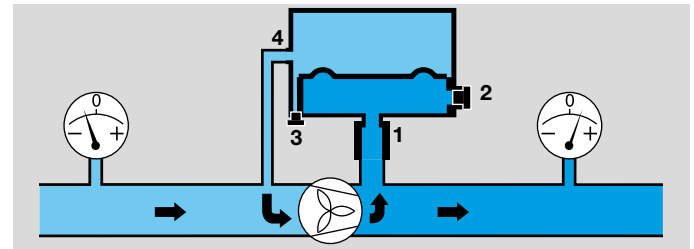
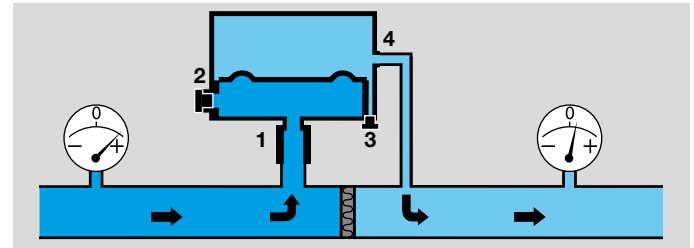

The higher absolute pressure is connected to port **1** (or **2**), and the lower absolute pressure to port **4** (or **3**). The remaining ports must be tightly plugged.

Function

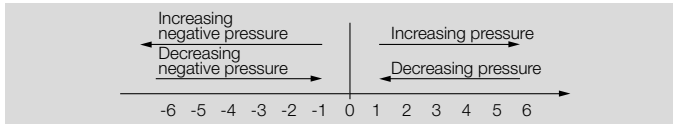

Do not connect port **4** (or **3**) to pipes carrying gas! For further information, see page 22 (Ports).

3.5 Connection diagram

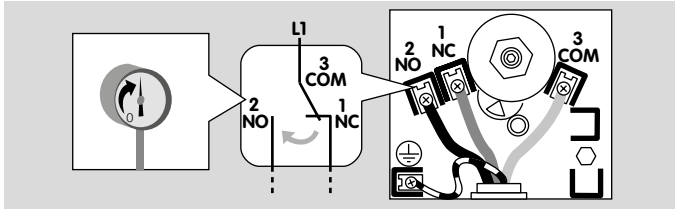

Contacts 3 and 2 close when subject to increasing pressure.
 Contacts 1 and 3 close when subject to falling pressure.

On pressure switches that switch with rising pressure:
 The contact switches from NC 1 to NO 2.

On pressure switches that switch with falling pressure:
 The contact switches from NO 2 to NC 1.

3.5.1 Blue pilot lamp for 230 V AC or for 110/120 V AC

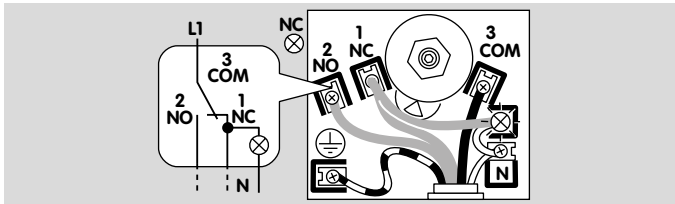
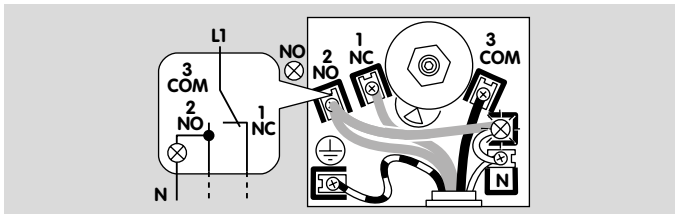

3.5.2 Pilot lamp with plug

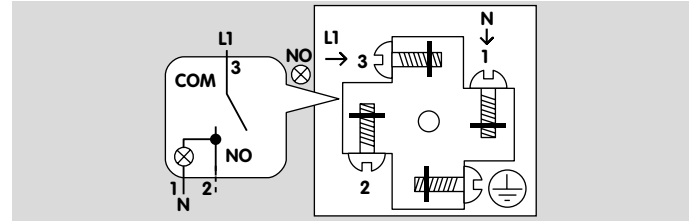

3.5.3 Red/green pilot LED for 24 V DC/AC or for 110 V AC to 230 V AC

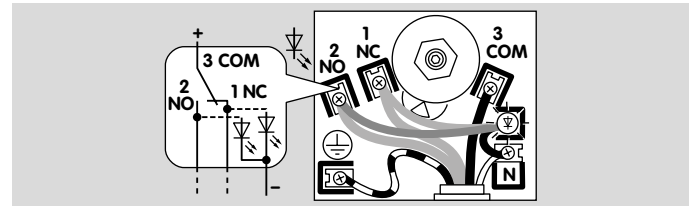

3.5.4 Pilot LED with plug

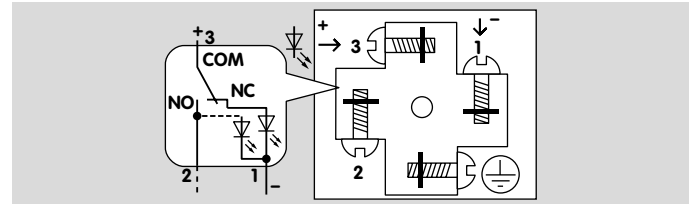

3.6 Wiring

If the DG..G has switched a voltage > 24 V and a current > 0.1 A at $\cos \varphi = 1$ or > 0.05 A at $\cos \varphi = 0.6$ once, the gold plating on the contacts will have been burnt through. It can then only be operated at this power rating or higher power rating.

When using silicone tubes, only use silicone tubes which have been sufficiently cured. Vapours containing silicone can adversely affect the functioning of electrical contacts. In the case of low switching capacities, such as 24 V, 8 mA, for example, we recommend using an RC module (22Ω , $1 \mu\text{F}$) in air containing silicone or oil.

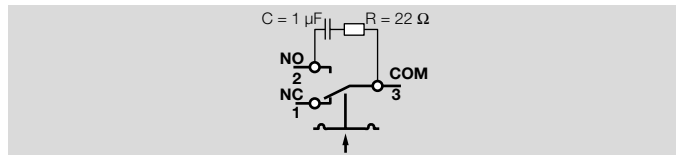

In the case of high humidity or aggressive gas components (H_2S), we recommend using a pressure switch with gold contact due to its higher resistance to corrosion. Closed-circuit current monitoring is recommended under difficult operating conditions.

All DG models (except DG..I)

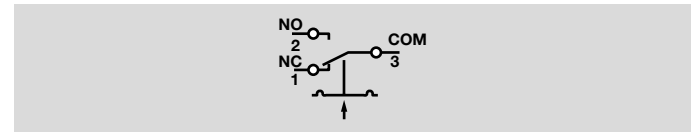

Contacts 3 and 2 close when subject to increasing pressure. Contacts 1 and 3 close when subject to falling pressure.

DG 18I, DG 120I, DG 450I

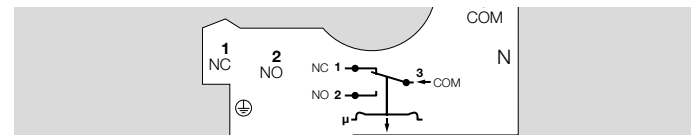

Contacts 3 and 2 close when subject to increasing negative pressure. Contacts 1 and 3 close when subject to falling negative pressure.

DG 1,5I and DG 12I

The connection of DG 1,5I and DG 12I depends on the positive or negative adjusting range.

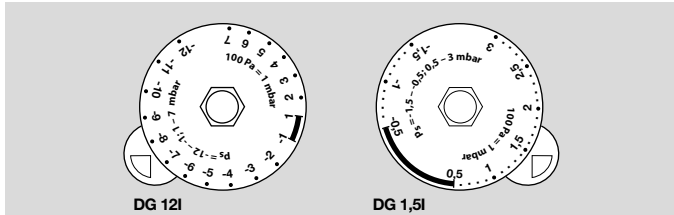

In the negative adjusting range, the template which can be found in the unit displays the connection diagram.

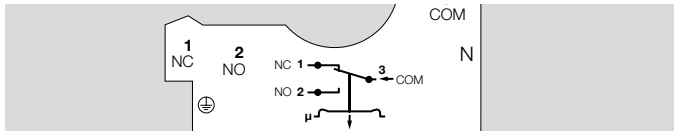

In the positive adjusting range, remove the template and wire the unit as shown in the engraved connection diagram.

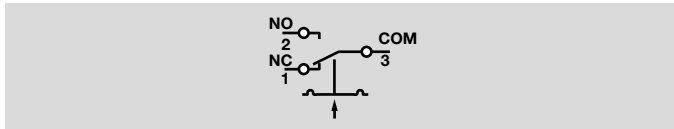

3.7 DG in Zone 1 (21) and 2 (22) hazardous areas

Pressure switch DG can be used in Zone 1 (21) and 2 (22) hazardous areas if an isolating amplifier is installed upstream in the safe area as “Ex-i” equipment pursuant to EN 60079-11:2012 (VDE 0170-7).

DG as “simple electrical equipment” pursuant to EN 60079-11:2012, Section 5.7, corresponds to the Temperature class T6, Group II. The internal inductance/capacitance is $L_i = 0.2 \mu\text{H}/C_i = 8 \text{ pF}$.

The isolating amplifier transfers the DG’s signals from the explosion-hazard area to the safe area. Depending on the design of the intrinsically safe circuit, the explosion-hazard area can be monitored for cable faults, cable discontinuities or short-circuits.

Ensure that standard-compliant wiring pursuant to EN 60079 is used.

When operating in Zones 21 and 22, the $\frac{1}{8}$ " connecting thread or the tube connection for the surrounding air or medium connection must be protected from dirt particles by a separate filter.

Intrinsically safe circuit without monitoring for cable faults

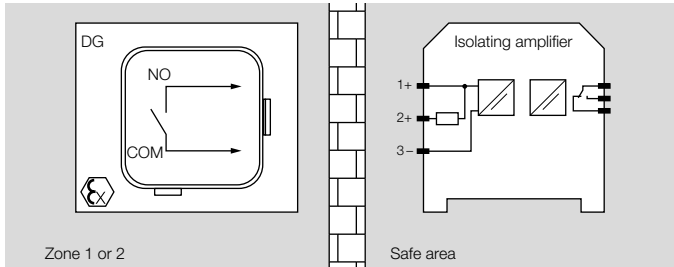

3.8 DG on pipes with Zone 2 (22) explosive atmospheres

Pressure switch DG can be connected to pipes/rooms in which Zone 2 (22) explosive gases or dust are present without an isolating amplifier.

The connection to Zone 2, Zone 22 must be implemented via one of the two 1/4" threads. Even in the unlikely event of a break in the diaphragm, there is no danger of flashback into the system. The pressure compensation holes on the pressure switch (1/4" connections) have a defined ignition protection, in terms of the safety measure for "enclosed-break devices for Group IIA gases and vapours", pursuant to IEC/EN 60079-15.

In the case of Zone 22, it must be ensured that dirt particles do not block the pressure supply hole ($\varnothing = 0.8 \text{ mm}$).

Intrinsically safe circuit with monitoring for cable discontinuities

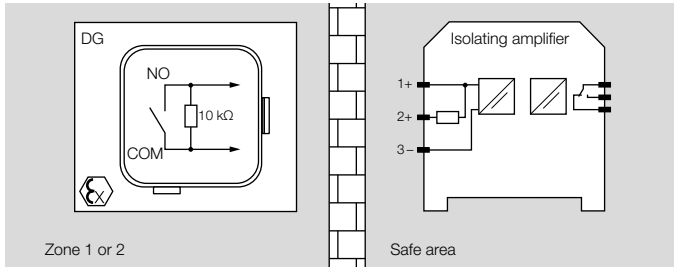

Intrinsically safe circuit with monitoring for cable faults and short-circuits

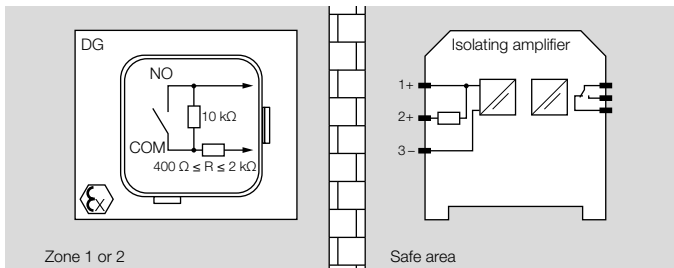

3.9 Animation

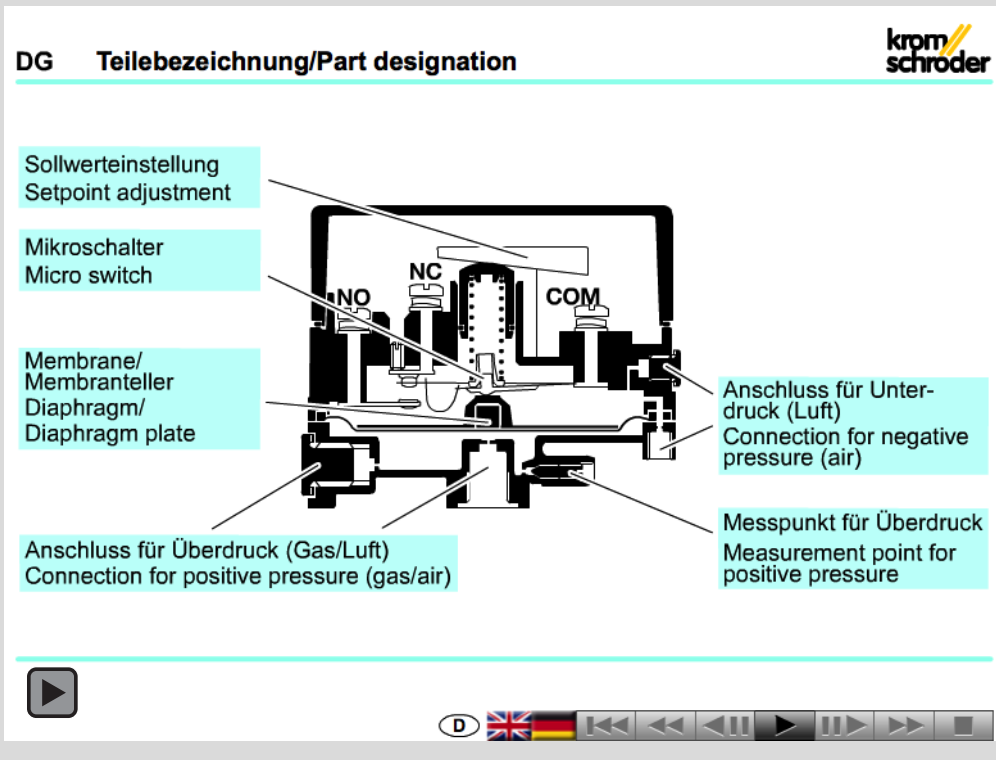

The interactive animation shows the function of the gas pressure switch DG.

Click on the picture. The animation can be controlled using the control bar at the bottom of the window (as on a DVD player).

To play the animation, you will need Adobe Reader 7 or a newer version. If you do not have Adobe Reader on your system, you can download it from the Internet.

If the animation does not start to play, you can download it from the document library (Docuthek) as an independent application.

4 Selection

Switching properties, see page 5 (Use).

4.1 Selection table

		DG..B, DG..BN, DG..U, DG..UN																														
Type	1.5	6	10	12	18	30	50	120	150	400	450	500	B	U	BN	UN	H	N	I	S	G	-3	-4	-5	-6	-9	K2	T	T2	N	A	
DG	-	●	●	-	-	●	●	-	●	●	-	●	●	●	●	●	-	-	-	-	○	●	○	○	○	○	○	○	○	○	○	○

		DG..H, DG..N																														
Type	1.5	6	10	12	18	30	50	120	150	400	450	500	B	U	BN	UN	H	N	I	S	G	-3	-4	-5	-6	-9	K2	T	T2	N	A	
DG	-	-	●	-	-	-	●	-	●	-	-	●	-	-	-	-	●	●	-	-	○	●	○	○	○	○	○	○	○	○	○	○

		DG..S																														
Type	1.5	6	10	12	18	30	50	120	150	400	450	500	B	U	BN	UN	H	N	I	S	G	-3	-4	-5	-6	-9	K2	T	T2	N	A	
DG	-	●	●	-	-	●	●	-	●	●	●	-	-	-	-	-	-	-	-	●	○	●	○	○	○	○	○	○	○	○	○	○

		DG..I																														
Type	1.5	6	10	12	18	30	50	120	150	400	450	500	B	U	BN	UN	H	N	I	S	G	-3	-4	-5	-6	-9	K2	T	T2	N	A	
DG	●	-	-	●	●	-	-	●	-	-	●	-	-	-	-	-	-	-	-	●	-	○	●	○	○	○	○	○	○	○	○	○

● = standard, ○ = available, - = not available

Order example

DG 10U-3

		DG..T, DG..FT, DG..HT, DG..NT, DG..ST																			
Type	6	10	50	150	500	F ¹⁾	H ¹⁾	N ¹⁾	S ¹⁾	-T	G	-2	-4	-9	1	2	K2	T2	N	A	
DG	●	●	●	●	●	○	○	○	○	●	○	●	○	○	●	○	○	○	○	○	○

1) "no" letter = DG..T switches with rising pressure.

● = standard, ○ = available

4.2 Type code

4.2.1 DG

Code	Description
DG	Gas pressure switch
1.5	Negative pressure, adjusting range -1.5 to -0.5/+0.5 to +3 mbar
6	Adjusting range 0.4 to 6 mbar
10	Adjusting range 1 to 10 mbar
12	Negative pressure, adjusting range -12 to -1/+1 to +7 mbar
18	Negative pressure, adjusting range -2 to -18 mbar
30	Adjusting range 2.5 to 30 mbar
50	Adjusting range 2.5 to 50 mbar
120	Negative pressure, adjusting range -10 to -120 mbar
150	Adjusting range 30 to 150 mbar
400	Adjusting range 50 to 400 mbar
450	Negative pressure, adjusting range -80 to -450 mbar
500	Adjusting range 100 to 500 mbar
B	Switches with rising positive pressure
U	Switches with rising positive, negative or differential pressure
BN	Switches with falling positive pressure
UN	Switches with falling positive, negative or differential pressure
H	Switches and locks off with rising pressure
N	Switches and locks off with falling pressure
I	Switches with rising negative pressure for gas
S	Switches with rising and falling pressure
	Positive pressure only, for oxygen and ammonia
G	With gold-plated contacts
	Electrical connection:
-3	screw terminals and M16 cable gland, IP 54
-4	screw terminals and M16 cable gland, IP 65
-5	with 4-pin plug, without socket
-6	with 4-pin plug, with socket, IP 54
-9	with 4-pin plug, with socket, IP 65
K2	Red/green pilot LED for 24 V DC/AC
T	Blue pilot lamp for 230 V AC
T2	Red/green pilot LED for 110 – 230 V AC
N	Blue pilot lamp for 110/120 V AC
A	External adjustment

Adjusting range, see page 30 (Adjusting range, switching hysteresis).

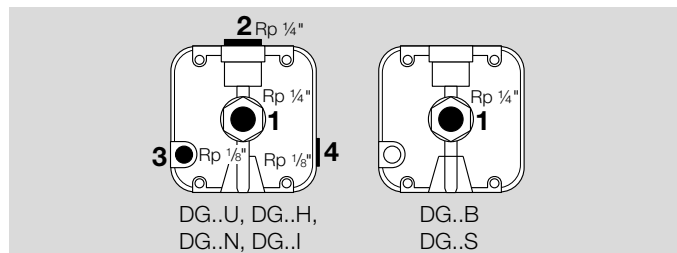

DG..U, DG..H, DG..N, DG..I:
ports **1** and **2**: Rp 1/4" (standard),
ports **3** and **4**: Rp 1/8" (standard).

DG..B, DG..S:
port **1**: Rp 1/4" (standard).

4.2.2 DG..T

Code	Description
DG	Gas pressure switch
6	Adjusting range 0.5 to 6 mbar
10	Adjusting range 1 to 10 mbar
50	Adjusting range 2.5 to 50 mbar
150	Adjusting range 30 to 150 mbar
500	Adjusting range 100 to 500 mbar
F ¹⁾	Switches with falling pressure
H ¹⁾	Switches and locks off with rising pressure
N ¹⁾	Switches and locks off with falling pressure
S ^{1), 2)}	Switches with rising and falling pressure
	Positive pressure only, for oxygen and ammonia
T	T-product
G	With gold-plated contacts
-2	Electrical connection: via screw terminals and ½" NPT conduit, IP 65
-4	via screw terminals and M16 cable gland, IP 65
-9	via 4-pin plug, with socket, IP 65
1	1 ¼" NPT connection
2	2 ¼" NPT connections
K2	Red/green pilot LED for 24 V DC/AC
T2	Red/green pilot LED for 110 – 230 V AC
N	Blue pilot lamp for 110/120 V AC
A	External adjustment

¹⁾ Letter omitted = DG..T switches with rising pressure

²⁾ Without approval

Adjusting range, see page 30 (Adjusting range, switching hysteresis).

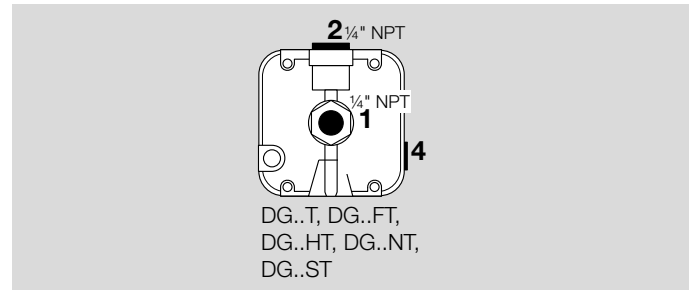







DG..T, DG..HT, DG..NT:
port **1**: ¼" NPT (standard) or
ports **1** and **2**: ¼" NPT (DG..T..2 available),
port **4**: ⅛" NPT (standard).

5 Project planning information

5.1 Installation

Installation in the vertical or horizontal position, or sometimes upside down, preferably with vertical diaphragm.

If installed in a vertical position, the switching point p_S will correspond to the scale value SK set on the hand wheel. If installed in another position, the switching point p_S will change and no longer correspond to the scale value SK set on the hand wheel. Switching point p_S must be checked.

		
All DG models (except DG..I)		
$p_S = SK$	$p_S = SK + 0.18 \text{ mbar (0,8 "WC)}$	$p_S = SK - 0.18 \text{ mbar (0,8 "WC)}$
DG 1,5I		
$p_S = SK$	$p_S = SK + 0.4 \text{ mbar}$ e.g. SK = 1.2: $p_S = 1.2 + 0.4 = 1.6 \text{ mbar}$ e.g. SK = -1.2: $p_S = -1.2 + 0.4 = -0.8 \text{ mbar}$	
DG 12I		
$p_S = SK$	$p_S = SK + 0.5 \text{ mbar}$ e.g. SK = 5: $p_S = 5 + 0.5 = 5.5 \text{ mbar}$ e.g. SK = -10: $p_S = -10 + 0.5 = -9.5 \text{ mbar}$	
DG 18I, DG 120I, DG 450I		
$p_S = SK$	DG 18I: $p_S = SK + 0.5 \text{ mbar}$ e.g. SK = -10: $p_S = -10 + 0.5 = -9.5 \text{ mbar}$ DG 120I, DG 450I: $p_S = SK + 0.2 \text{ mbar}$	

The housing must not be in contact with masonry. Minimum clearance 20 mm (0.8").

The DG..S is suitable for oxygen and ammonia only (diaphragm made of IIR). Do not use for fuel gases – diaphragm not resistant! In the case of oxygen, ensure grease-free installation.

Continuous operation at high temperatures (e.g. maximum ambient temperature) accelerates the ageing of elastomer materials and reduces the service life (please contact manufacturer). Ozone concentrations exceeding $200 \mu\text{g}/\text{m}^3$ or gases containing more than 0.1%-by-vol. H_2S accelerate the ageing of elastomer materials and reduce the service life.

Vapours containing silicone can adversely affect the functioning of electrical contacts. When using silicone tubes, only use silicone tubes which have been sufficiently cured.

Condensation must not be allowed to get into the housing (if possible, install pipework with an ascending gradient). Otherwise, there is a risk of icing of condensation at subzero temperatures, the switching point shifting or corrosion in the device which can lead to malfunctions.

Project planning information

When installing outdoors, place the DG in a roofed area and protect from direct sunlight (even IP 65 version). To avoid condensation, the cover with pressure equalization element can be used, see page 25 (Pressure equalization element).

The weather protection cover provides permanent protection when installed outdoors, see page 27 (Weather protection cover).

In case of highly fluctuating pressures, install a restrictor orifice, see page 25 (Filter pad set).

5.2 Ports

5.2.1 DG

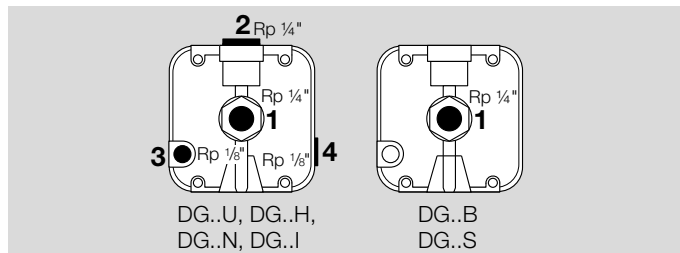

Positive pressure	Connect	Seal	Free*
DG..U, DG..H, DG..N, DG..UN	1	2	3 or 4
	2	1	
DG..B, DG..BN, DG..S	1	-	4

Negative pressure	Connect	Seal	Free*
DG..U, DG..H, DG..N	4	3	1 or 2
	3	4	
DG..I	1	2	3 or 4
	2	1	

* It is recommended that the port which is best protected from water and dirt be left open.

Differential pressure	Connect		Seal
	for the higher absolute pressure	for the lower absolute pressure	
DG..U, DG..H, DG..N, DG..UN	1 or 2	3 or 4	Seal ports that are not in use

Ports **3** and **4** are connected to the micro switch chamber.

Pipes carrying gas must not be connected to port **3** or **4**!

The port that is best protected against soiling (dust/humidity) is to be left open for ventilation (positive pressure measurement) to the atmosphere. If dust exposure in the environment is high, a filter pad, see page 25 (Filter pad set), or a filter is to be used in the open port.

5.2.2 DG..T

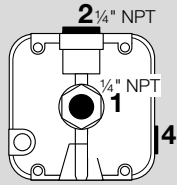

DG..T, DG..FT,
DG..HT, DG..NT,
DG..ST

Positive pressure	Connect	Seal	Free
DG..T, C6097	1	2	4
	2	1	

Negative pressure	Connect	Seal	Free
DG..T, C6097	4	-	1 or 2*

* Port 2 only on DG..T..2 with 2 connections (1/4" NPT).

Differential pressure	Connect	
	for the higher absolute pressure	for the lower absolute pressure
DG..T, C6097	1 or 2	4

Port **4** is connected to the micro switch chamber.

For this reason, pipes carrying gas must not be connected to port **4**!

If necessary, port **4** (1/8" NPT) can be used to connect the venting line.

A filter pad at port **4** protects the electrical contacts in the pressure switch from dirt particles in the surrounding air or in the medium.

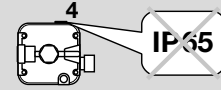

If port **4** is at the top, IP 65 will not be satisfied.

5.3 Resetting pressure switches with manual reset

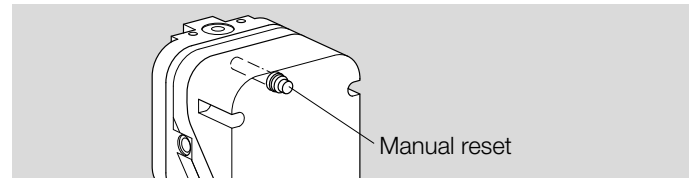

Pressure switches locking off if the pressure drops to the set switching point:

For resetting, the pressure must have risen to at least the set switching point **plus** the pressure differential between the switching pressure and possible reset.

Pressure switches locking off if the pressure rises to the set switching point:

For resetting, the pressure must have dropped to at least the set switching point **minus** the pressure differential between the switching pressure and possible reset.

Pressure differential, see page 30 (Adjusting range, switching hysteresis).

6 Accessories

6.1 Fastening set with screws, U-shape bracket

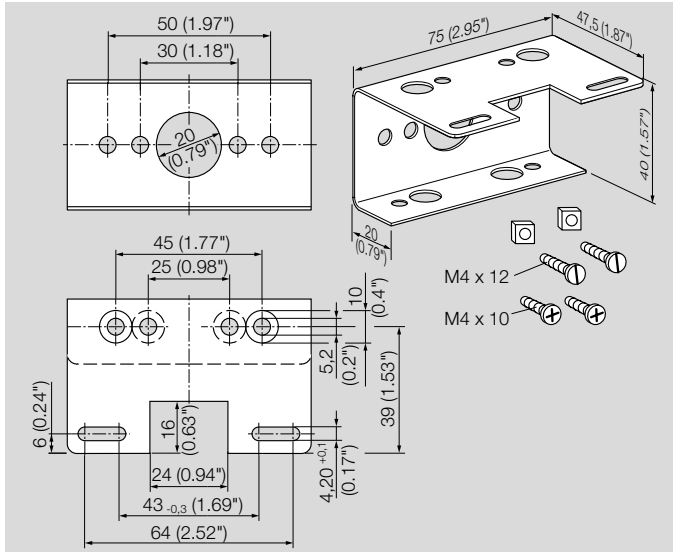

Order No.: 74915387

6.2 Connecting set



For monitoring a minimum and maximum inlet pressure with two pressure switches attached to one another.

Order No.: 74912250

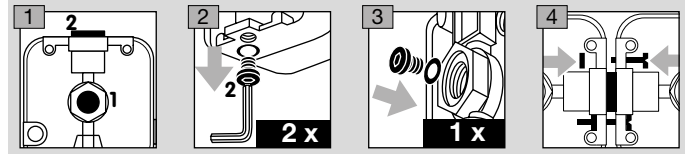

6.3 External adjustment

For CE certified pressure switches



In order to set the switching pressure from the outside, the cover for external adjustment (6 mm Allen key) for DG..B, DG..U and DG..I can be retrofitted.

Order No.: 74916155

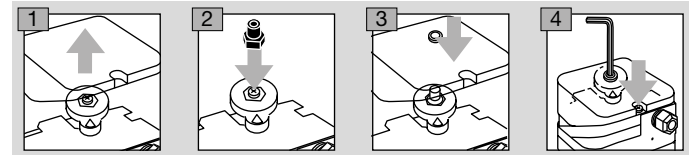

6.4 Pressure equalization element

For CE certified pressure switches

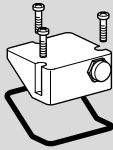

To avoid the formation of condensation, the cover with pressure equalization element can be used. The diaphragm in the screw connector is designed to ventilate the cover, without allowing water to enter.

Order No.: 74923391

6.5 Filter pad set

For CE certified pressure switches

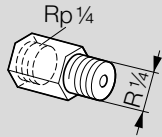

In the case of high pressure fluctuations, we recommend using a restrictor orifice (contains non-ferrous metals):

Hole diameter 0.2 mm, Order No.: 75456321

Hole diameter 0.3 mm, Order No.: 75441317

6.6 Test key PIA

For CE certified pressure switches

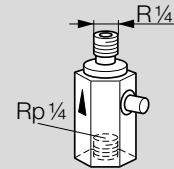

To test the min. pressure switch, the pressure switch can be vented in its switched state using the PIA test key (contains non-ferrous metals).

Order No.: 74329466

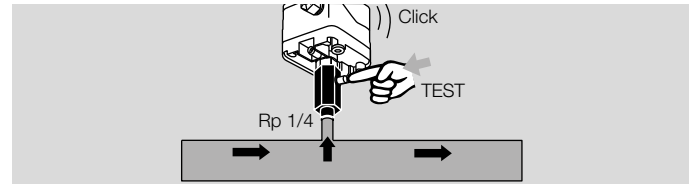

6.7 Filter pad set

To protect the electrical contacts in the DG from dirt particles in the surrounding air or in the medium, use a filter pad at the 1/8" negative pressure port. As standard on IP 65 units.

5-piece filter pad set, Order No.: 74916199

6.8 Tube set

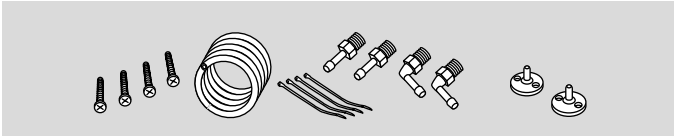

To be used with air only.

Order No.: 74912952

6.9 Standard socket set

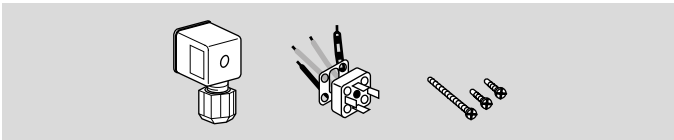

For CE certified pressure switches

Order No.: 74915388

For FM, UL certified pressure switches

Order No.: 75459526

6.10 Standard coupler plug

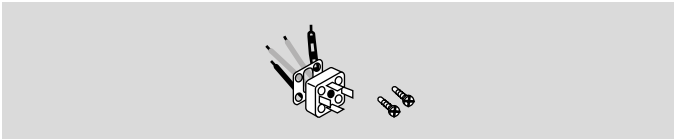

For CE certified pressure switches

Order No.: 74920412

For FM, UL certified pressure switches

Order No.: 75459525

6.11 Pilot lamp set, red or blue

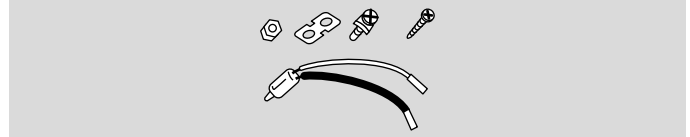

Pilot lamp, red:

110/120 V AC, I = 1.2 mA, Order No.: 74920430

230 V~ V AC, I = 0.6 mA, Order No.: 74920429

Pilot lamp, blue:

110/120 V AC, I = 1.2 mA, Order No.: 74916121

230 V~ V AC, I = 0.6 mA, Order No.: 74916122

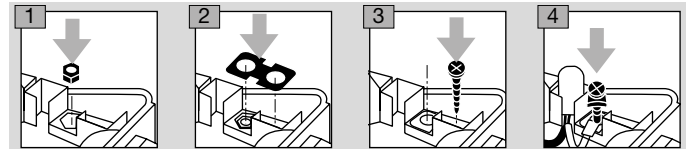

6.12 LED set, red/green

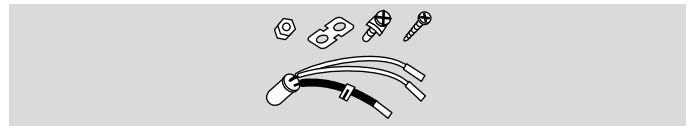

24 V DC, I = 16 mA; 24 V AC, I = 8 mA, Order No.: 74921089,

110 V~ to 230 V~, Order No.: 74923275

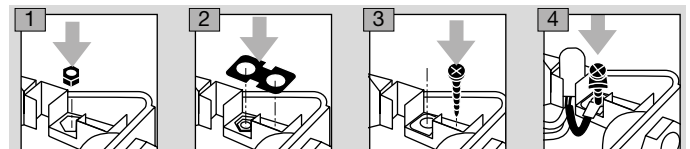

6.13 Weather protection cover

When the DG is installed outdoors, the weather protection cover provides permanent protection against condensation and weathering of housing parts.

The weather protection cover is made of 1 mm-thick stainless steel.

Installation position: vertical with the cable gland pointing downwards.

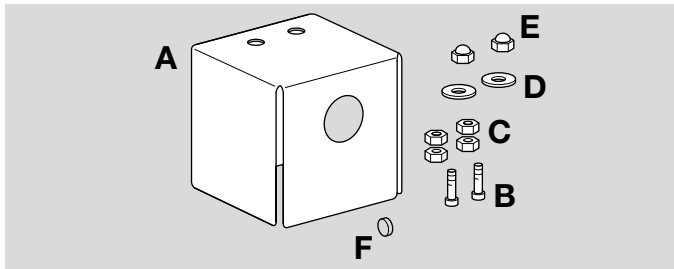

2 M4 x 16 screws with 2 cap nuts.

The enclosed filter pad is designed to protect the open 1/8" port from the ingress of dirt or insects.

Scope of delivery:

A 2 x covers, 100 x 100 x 100 mm

B 2 x M4 x 16 screws

C 4 x nuts

D 2 x washers

E 2 x cap nuts

F 1 x filter pad (1/8" port)

Order No.: 74924909.

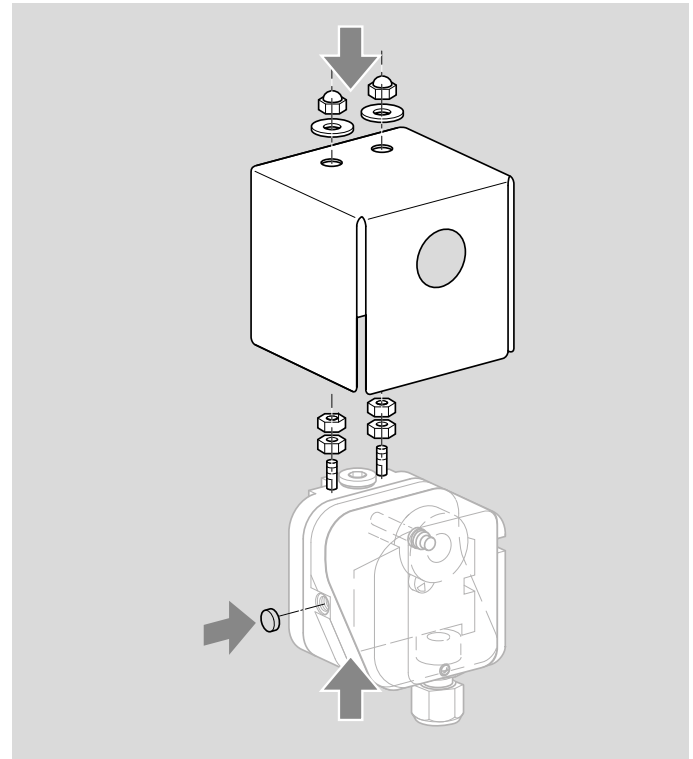

7 Technical data

Gas type: natural gas, town gas, LPG (gaseous), flue gas, biogas (max. 0.1%-by-vol. H₂S) and air.

DG: max. inlet pressure p_{\max} = withstand pressure, see page 30 (Adjusting range, switching hysteresis).

Max. test pressure for testing the entire system: temporarily < 15 minutes 2 bar (29 psig).

Switching capacity:

	U	I (cos φ = 1)	I (cos φ = 0.6)
DG	24 - 250 V~	0.05 - 5 A	0.05 - 1 A
DG..G	5 - 250 V~	0.01 - 5 A	0.01 - 1 A
	5 - 48 V=	0.01 - 1 A	
DG..T	max. 240 V~	max. 5 A	max. 0.5 A
DG..TG	< 30 V~/=	max. 0.1 A	max. 0.05 A

If the DG (DG..TG) has switched a voltage > 24 V (> 30 V) and a current > 0.1 A at cos φ = 1 or > 0.05 A at cos φ = 0.6 once, the gold plating on the contacts will have been burnt through. It can then only be operated at this power rating or higher power rating.

Maximum medium and ambient temperatures:

DG..B, DG..U, DG..I: -20 to +80°C (-4 to +176°F),

DG..S: -15 to +60°C (5 to 140°F),

DG..H, DG..N: -15 to +60°C (5 to 140°F),

DG..T, DG..FT, DG..HT, DG..NT:

-40 to +60 °C (-40 to +140 °F).

Long-term use in the upper ambient temperature range accelerates the ageing of the elastomer materials and reduces the service life (please contact manufacturer).

The set switching point may palpably change in media and ambient temperatures below -22°F (-30 °C).

Storage and transport temperature:

DG, DG..T: -20 to +40 °C (-4 to +104 °F).

Diaphragm pressure switch, silicone-free.

Diaphragm:

NBR

IIR for DG..S, DG..ST.

Housing: glass fibre reinforced PBT plastic with low gas release.

Lower housing section: AlSi 12.

Enclosure:

DG: IP 54 or IP 65, safety class. 1.

DG..T: IP 65, safety class: 1.

Cable diameter: AWG 24 to AWG 13, 0.5 to 1.8 mm (0.02 to 0.07").

Line entrance:

M16 x 1.5 cable gland,

clamping range: diameters of 4 to 10 mm,

DG..T, DG..FT, DG..HT, DG..NT, DG..ST:

½" NPT conduit cable gland.

Electrical connection type:

screw terminals.

Technical data

Recommended tightening torque:

Component	Tightening torque [Ncm]
Cover screws	65
M16 x 1.5 cable gland	50
½" NPT Conduit	170 (15 lb")
Rp ½ pipe connection, aluminium	250
Rp ¼ (¼" NPT) gas connection	1300
Rp ½ air connection, switch housing	250
Clamping terminal screws	80
T15 test point screw	150

Weight: 270 to 320 g (9.5 to 11.3 oz), depending on equipment.

7.1 Adjusting range, switching hysteresis

7.1.1 DG

Switching properties, see page 5 (Use).

Type	Adjusting range*	Mean switching differential at min. and max. setting	Max. inlet pressure $p_{\max.}$ = withstand pressure	Difference between switching pressure and possible reset	Deviation from the switching point during testing pursuant to EN 1854	
					Gas pressure switch	Air pressure switch
	mbar	mbar	mbar	mbar		
DG 6U, DG 6B, DG 6S	0.5 – 6	0.2 – 0.3	100	–	± 15%	± 15% or 0.1 mbar
DG 10U, DG 10B, DG 10S	1 – 10	0.25 – 0.4	500	–	± 15%	± 15%
DG 30U, DG 30B, DG 30S	2.5 – 30	0.35 – 0.9	500	–	± 15%	± 15%
DG 50U, DG 50B, DG 50S	2.5 – 50	0.8 – 1.5	500	–	± 15%	± 15%
DG 150U, DG 150B, DG 150S	30 – 150	3 – 5	600	–	± 15%	± 15%
DG 400U, DG 400B, DG 400S	50 – 400	5 – 15	600	–	± 15%	± 15%
DG 500U, DG 500B, DG 500S	100 – 500	8 – 17	600	–	± 15%	± 15%
DG 10H, DG 10N	1 – 10	–	600	0.4 – 1	± 15%	± 15%
DG 50H, DG 50N	2.5 – 50	–	600	1 – 2	± 15%	± 15%
DG 150H, DG 150N	30 – 150	–	600	2 – 12	± 15%	± 15%
DG 500H, DG 500N	100 – 500	–	600	5 – 18	± 15%	± 15%

* Adjusting tolerance = ± 15% of the scale value.

Type	Adjusting range* [mbar]	Max. inlet pressure $p_{\max.}$ = withstand pressure [mbar]	Mean switching differential at min. and max. setting [mbar]	Deviation from the switching point during testing pursuant to EN 1854	
				Gas pressure switch	Air pressure switch
DG 1,5I	-1.5 to -0.5 and +0.5 to +3	± 100	0.2 – 0.5	± 15%	± 15% or 0.4 mbar
DG 12I	-12 to -1 and +1 to +7	± 100	0.5 – 1	± 15%	± 15% or 0.5 mbar
DG 18I	-2 to -18	± 100	0.5 – 1.5	± 15%	± 15% or 0.5 mbar
DG 120I	-10 to -120	± 600	4 – 11	± 15%	± 15%
DG 450I	-80 to -450	± 600	10 – 30	± 15%	± 15%

* Adjusting tolerance = ± 15% of the scale value.

7.1.2 DG..T

Switch-on/Switch-off point, see page 5 (Use).

Type	Adjusting range ¹⁾	Mean switching differential at min. and max. setting	Max. inlet pressure		Difference between switching pressure and possible reset	Deviation from the switching point during testing pursuant to EN 1854	
			with	without		Gas pressure switch	Air pressure switch
	"WC (mbar)	"WC (mbar)	venting line ²⁾		"WC (mbar)		
			psi (mbar)	psi (mbar)			
DG 6T, DG 6FT, DG 6ST	0.2 – 2.4 (0.5 – 6)	0.08 – 0.12 (0.2 – 0.3)	8.5 (600)	2.4 (165)	–	± 15%	± 15% or 0.04 "WC
DG 10T, DG 10FT, DG 10ST	0.4 – 4 (1 – 10)	0.1 – 0.16 (0.25 – 0.4)	8.5 (600)	7 (480)	–	± 15%	± 15% or 0.04 "WC
DG 50T, DG 50FT, DG 50ST	1 – 20 (2.5 – 50)	0.3 – 0.6 (0.8 – 1.5)	8.5 (600)	7 (480)	–	± 15%	± 15%
DG 150T, DG 150FT, DG 150ST	12 – 60 (30 – 150)	1.2 – 2 (3 – 5)	8.5 (600)	7 (480)	–	± 15%	± 15%
DG 500T, DG 500FT, DG 500ST	40 – 200 (100 – 500)	3.2 – 6.8 (8 – 17)	8.5 (600)	7 (480)	–	± 15%	± 15%
DG 10HT, DG 10NT	0.4 – 4 (1 – 10)	–	8.5 (600)	7 (480)	0.16 – 0.4 (0.4 – 1)	± 15%	± 15%
DG 50HT, DG 50NT	1 – 20 (2.5 – 50)	–	8.5 (600)	7 (480)	0.4 – 0.8 (1 – 2)	± 15%	± 15%
DG 150HT, DG 150NT	12 – 60 (30 – 150)	–	8.5 (600)	7 (480)	0.8 – 4.8 (2 – 12)	± 15%	± 15%
DG 500HT, DG 500NT	40 – 200 (100 – 500)	–	8.5 (600)	7 (480)	2 – 7.2 (5 – 18)	± 15%	± 15%

¹⁾ Adjusting tolerance = ± 15% of the scale value.

²⁾ Venting line connected to port 4, see page 22 (Anschlüsse).

7.2 Safety-specific characteristic values for DG

For SIL	
Suitable for Safety Integrity Level	SIL 1, 2, 3
Diagnostic coverage DC	0
Type of subsystem	Type A to EN 61508-2, 7.4.3.1.2
Mode of operation	High demand mode pursuant to EN 61508-4, 3.5.12
For PL	
Suitable for Performance Level	PL a, b, c, d, e
Category	B, 1, 2, 3, 4
Common cause failure CCF	> 65
Application of essential safety requirements	Satisfied
Application of tried-and-tested safety requirements	Satisfied
For SIL and PL	
	B_{10d} value
U = 24 V DC, I = 10 mA; U = 230 V AC, I = 4 mA	6,689,477 operating cycles
U = 24 V DC, I = 70 mA; U = 230 V AC, I = 20 mA	4,414,062 operating cycles
U = 230 V AC, I = 2 A	974,800 operating cycles
Hardware fault tolerance (1 component/switch) HFT	0
Hardware fault tolerance (2 components/switches, redundant operation) HFT	1
Safe failure fraction SFF	> 90%
Fraction of undetected common cause failures β	$\geq 2\%$

Max. service life under operating conditions:
10 years after date of production, plus max. ½ year in storage prior to first use, or once the given number of operating cycles has been reached, depending on which is achieved first.

The pressure switches are suitable for single-channel systems (HFT = 0) up to SIL 2/PL d, and up to SIL 3/PL e when two redundant pressure switches are installed in a double-channel architecture (HFT = 1), provided that the complete system complies with the requirements of EN 61508/ISO 13849.

For a glossary of terms, see page 35 (Glossary).

7.2.1 Determining the PFH_D value, the λ_D value and the MTTF_d value

$$PFH_D = \lambda_D = \frac{1}{MTTF_d} = \frac{0.1}{B_{10d}} \times n_{op}$$

7.2.2 Calculating the PFH_D and PFD_{avg}

Switch. cap.	
n _{op}	1/h
n _{op}	1/a
Cycle time	s
B _{10d}	
T _{10d}	a
PFH _D (1 DG)	1/h
PFD _{avg} (1 DG)	
Suitable for	
PFH _D (2 DG)	1/h
PFD _{avg} (2 DG)	
Suitable for	

PFH_D = Probability of dangerous failure (HDM = high demand mode) [1/hour]

PFD_{avg} = Average probability of dangerous failure on demand (LDM = low demand mode)

λ_D = Mean dangerous failure rate [1/hour]

MTTF_d = Mean time to dangerous failure [hours]

n_{op} = Demand rate (mean number of annual operations) [1/hour]

7.3 Dimensions

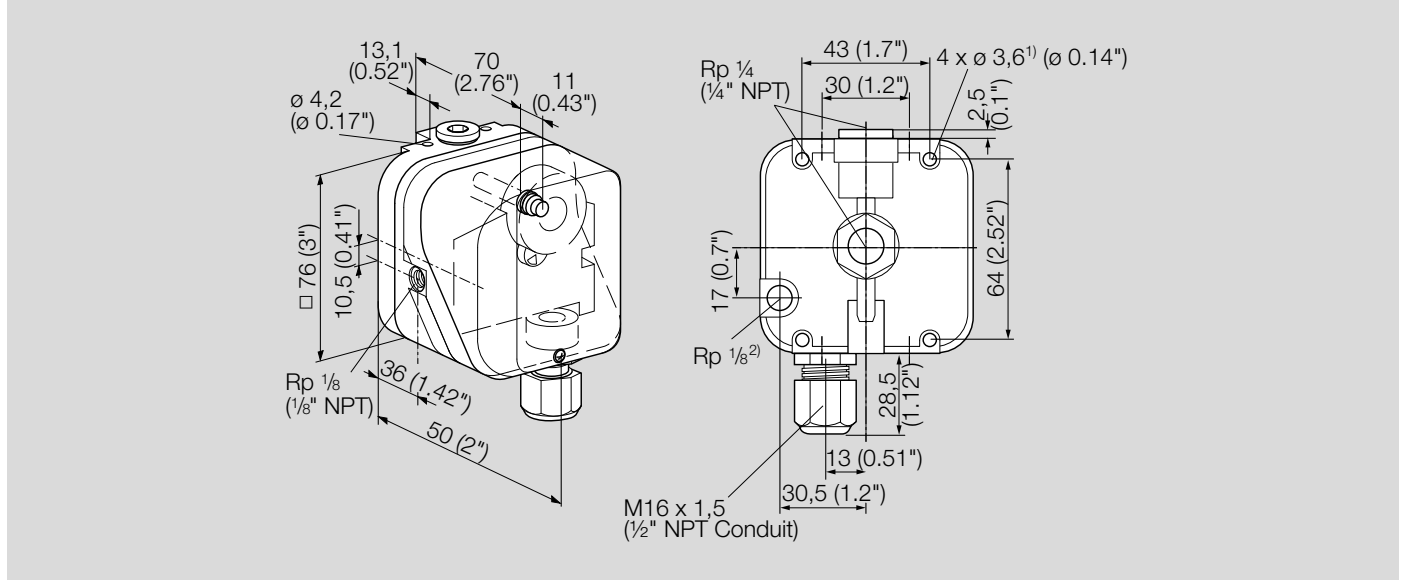

1) Holes 10 mm (0.4") deep, for self-tapping screws.

2) For DG..U, DG..H, DG..N, DG..I.

7.4 Converting units

See www.adlatus.org

8 Maintenance cycles

At least once a year, twice a year in the case of biogas.

9 Glossary

9.1 Diagnostic coverage DC

Measure of the effectiveness of diagnostics, which may be determined as the ratio between the failure rate of detected dangerous failures and the failure rate of total dangerous failures

NOTE: Diagnostic coverage can exist for the whole or parts of a safety-related system. For example, diagnostic coverage could exist for sensors and/or logic system and/or final elements. Unit:%.

see EN ISO 13849-1

9.2 Mode of operation

High demand mode or continuous mode

Operating mode, where the frequency of demands for operation made on a safety-related system is greater than one per year or greater than twice the proof-test frequency

see EN 61508-4

9.3 Category

Classification of the safety-related parts of a control system in respect of their resistance to faults and their subsequent behaviour in the fault condition, and which is achieved by the structural arrangement of the parts, fault detection and/or by their reliability

see EN ISO 13849-1

9.4 Common cause failure CCF

Failures of different items, resulting from a single event, where these failures are not consequences of each other

see EN ISO 13849-1

9.5 Fraction of undetected common cause failures β

Fraction of undetected failures of redundant components due to a single event, whereby these failures are not based on mutual causes

NOTE: β is expressed as a fraction in the equations and as a percentage elsewhere

see EN 61508-6

9.6 B_{10d} value

Mean number of cycles until 10% of the components fail dangerously

see EN ISO 13849-1

9.7 T_{10d} value

Mean time until 10% of the components fail dangerously

see EN ISO 13849-1

9.8 Hardware fault tolerance HFT

A hardware fault tolerance of N means that $N + 1$ is the minimum number of faults that could cause a loss of the safety function

see IEC 61508-2

9.9 Mean dangerous failure rate λ_D

Mean rate of dangerous failures during operation time (T_{10d}). Unit: 1/h.

see EN ISO 13849-1

9.10 Safe failure fraction SFF

Fraction of safe failures related to all failures, which are assumed to appear

see EN 13611/A2

9.11 Probability of dangerous failure PFH_D

Value describing the likelihood of dangerous failure per hour of a component for high demand mode or continuous mode. Unit: 1/h.

see EN 13611/A2

9.12 Mean time to dangerous failure $MTTF_d$

Expectation of the mean time to dangerous failure

see EN ISO 13849-1

9.13 Demand rate n_{op}

Mean number of annual operations

from EN ISO 13849-1

9.14 Average probability of dangerous failure on demand PFD_{avg}

(LDM = 1 – 10 switching cycles/year)

Average probability of a dangerous failure of the safety function on demand (LDM = low demand mode)

see EN 61508-6

Feedback

Finally, we are offering you the opportunity to assess this “Technical Information (TI)” and to give us your opinion, so that we can improve our documents further and suit them to your needs.

Clarity

Found information quickly
Searched for a long time
Didn't find information
What is missing?
No answer

Comprehension

Coherent
Too complicated
No answer

Scope

Too little
Sufficient
Too wide
No answer



Use

To get to know the product
To choose a product
Planning
To look for information

Navigation

I can find my way around
I got “lost”
No answer

My scope of functions

Technical department
Sales
No answer

Remarks

Contact

Elster GmbH
Postfach 2809 · 49018 Osnabrück
Strothweg 1 · 49504 Lotte (Büren)
Germany

Tel. +49 541 1214-0
Fax +49 541 1214-370
info@kromschroeder.com
www.kromschroeder.com

The current addresses of our international agents
are available on the Internet:
www.kromschroeder.de/Weltweit.20.0.html?&L=1

We reserve the right to make technical
modifications in the interests of progress.
Copyright © 2018 Elster GmbH
All rights reserved.

