

APPLICATION

These gas controls combine a Lite-Rite manual gas cock, safety shutoff Pilotstat assembly, millivoltage automatic valve operator, and optional gas pressure regulator. They require the use of a 750 mv Powerpile generator (thermopile). The generator, heated by the pilot burner flame, provides the electrical energy to operate the combination gas control.

A millivoltage thermostat with suitable accessory controls completes the automatic control system for the heating appliance.

Models equipped with the standard pressure regulator are identified by the suffix letter "A" (VS820A.) Models without pressure regulator carry the suffix letter "B" (VS820B). Suffix letter "C" (VS820C) identifies models having step opening type regulators.

Pressure regulators and operator are standardized and interchangeable on all models in the two capacity ranges — 225 and 335 cubic feet per hour.

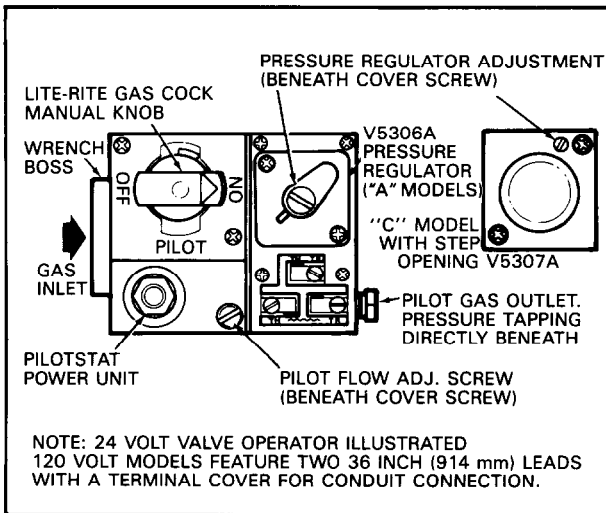

Fig. 1 — Top view A model. Pressure regulator for "C" model illustrated at right. (Blank cover plate (Part No. 392782) is available to convert an "A" model to a "B" model without pressure regulator.)

INSTALLATION

CAUTION

1. Installer must be experienced, trained serviceman.
2. Turn off gas supply before starting installation.
3. Do not remove seal over control inlet or outlet until ready to connect piping.

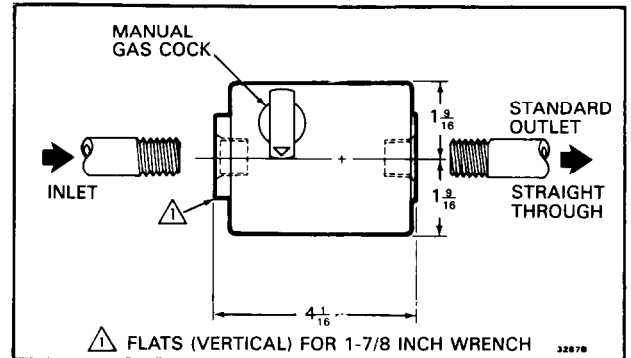

Fig. 2 — Piping pattern and dimensions (in inches) of VS820.

SIZE PIPE TAPPINGS

CONTROL CAPACITY (BTU/HR-NAT. GAS)	INLET TAPPING	OUTLET — STRAIGHT THROUGH
225,000	1/2	1/2
335,000	3/4	3/4

PREPARE AND INSTALL PIPE

1. Use new, properly reamed pipe free from chips.
2. Do not thread pipe too far. Valve distortion or malfunction may result from excess pipe within control.

LENGTH OF STANDARD PIPE THREADS (inches)

PIPE SIZE	EFFECTIVE LENGTH OF THREAD	OVERALL LENGTH OF THREAD
1/2	1/2	3/4
3/4	1/2-9/16	13/16

3. Apply moderate amount of good quality dope to pipe only, leaving two end threads bare. If LP gas installation, use compound resistant to action of liquified petroleum gases.

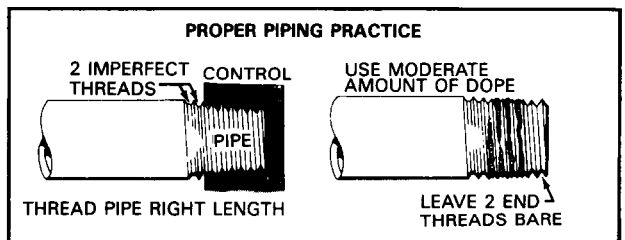

4. Install drip leg in gas supply pipe. (Fig. 3)

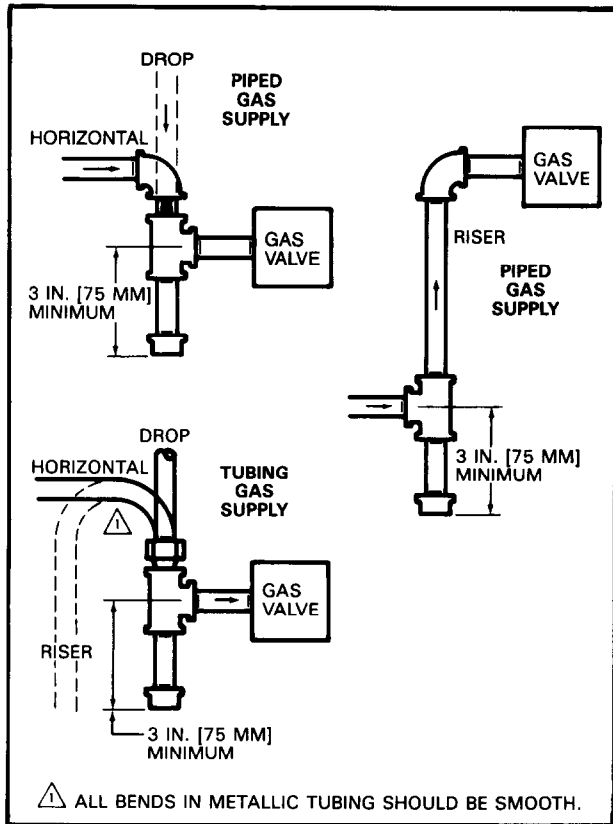

Fig. 3 — SEDIMENT TRAP (DRIP LEG) INSTALLATION.

INSTALL CONTROL

1. These controls can be mounted 0-90 degrees, in any direction, from the upright position of the gas cock knob.

2. Install the control so that gas supply is connected to the end provided with projecting boss for wrench application. See Fig. 1.

CONNECT PILOT GAS TUBING

1. Square off and remove burrs from end of tubing. Bend tubing to desired form for routing to pilot burner.

CAUTION

Do not bend tubing at control after compression nut has been tightened, as this may result in gas leakage at the connection.

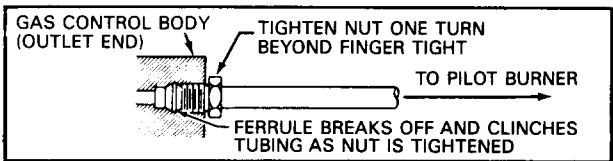

2. Slip compression fitting over tubing and slide out of way. Push tubing into pilot gas tapping on outlet end of control (Fig. 1) until it bottoms. While holding tubing all the way in, slide fitting into place and engage threads — turn until finger tight. Then use wrench and tighten one turn beyond finger tight.

3. Connect other end of tubing to pilot burner according to the pilot burner manufacturer's instructions.

WIRING

IMPORTANT

Follow circuit diagram provided by appliance manufacturer. If not furnished, refer to typical procedure outlined below.

All wiring must comply with local electrical codes and ordinances.

CAUTION

Never connect these millivoltage controls to line voltage or to a transformer.

Since the entire system is powered by the millivoltage generated by the Powerpile generator, it is important to clean and scrape all wires before connecting. Solder and tape all necessary splices using rosin flux to prevent corrosion. Tighten terminal screws. Total control circuit wiring must not exceed 30 feet of 2-wire 18 gauge cable, or 50 feet of 2-wire 16 gauge cable.

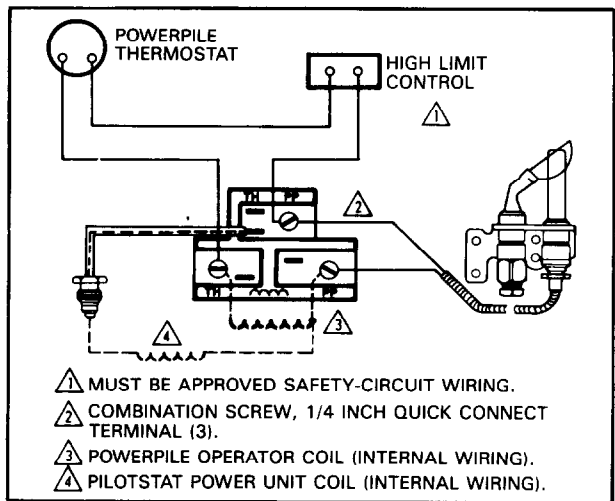

Fig. 4 — Typical Powerpile system wiring diagram.

1. Install Powerpile thermostat, limit control (if required), and Powerpile generator according to manufacturer's installation instructions.

2. After Powerpile generator is installed, route generator lead to Powerpile operator and connect to Powerpile terminals labeled PP. Make certain jumper lead from Powerpile operator to safety shutoff Pilotstat power unit is connected and tightened 1/4 turn beyond finger tight.

3. Route wires from control circuit and connect to the two Powerpile operator terminals labeled TH.

START-UP AND ADJUSTMENTS

GAS COCK SETTINGS (Refer to Fig. 1)

The Lite-Rite gas cock knob has three settings:
OFF, prevents any gas from passing through valve

to either main or pilot burner.

PILOT, which permits gas to flow to pilot burner only (when gas cock knob is held depressed or when generator is heated sufficiently to hold valve open).

ON, which permits gas to flow to both main and pilot burners when the system is calling for heat.

PILOT LIGHTING PROCEDURE

1. Slightly depress Lite-Rite knob if at PILOT position and turn clockwise  to OFF. Wait 5 minutes for all unburned gas to vent. REMEMBER that LP gas does not vent upward naturally.

2. Turn the Lite-Rite knob to PILOT, depress it completely, and light the pilot burner. The knob must be held down about one minute before the pilot burner will stay lit after releasing the knob.



3. Turn the knob to ON, and set the thermostat above room temperature to turn on main burner.

TEST FOR GAS LEAKS

WARNING — DO NOT OMIT THIS TEST

With main burner in operation, paint pipe joints, pilot gas tubing connections, and valve gasket lines with rich soap and water solution. Bubbles indicate gas leakage. To stop leak, tighten joints and screws or replace the gasket.

ADJUST PILOT FLAME

The pilot flame should envelop $3/8$ to $1/2$ inch of the tip of the thermocouple. Remove pilot adjustment cover screw (refer to Fig. 1). Turn inner adjustment screw clockwise  to decrease or counterclockwise  to increase pilot flame. Be sure to replace cover after adjustment to prevent possible gas leakage.

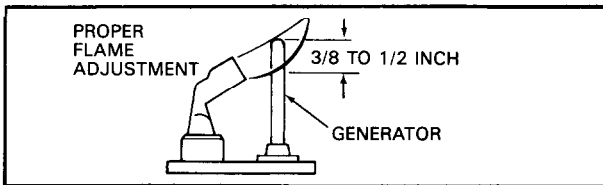

CHECK GAS INPUT TO APPLIANCE

IMPORTANT

Do not exceed input rating stamped on nameplate of appliance, or manufacturer's recommended burner orifice pressure for size orifice(s) used. Make certain primary air supply to main burner is properly adjusted for complete combustion. Follow instructions of appliance manufacturer if provided.

NOTE: IF METER CLOCKING METHOD IS USED



Make certain there is no gas flow through the meter other than to the appliance being checked. Other appliances must remain off, and the pilot extinguished (or their consumption deducted from the meter reading).

CAUTION

IF MANIFOLD PRESSURE METHOD IS USED, be sure gas cock is in PILOT position before removing pressure tap plug to connect pressure gauge (manometer). Also turn gas cock back to PILOT when removing gauge and replacing plug. Repeat gas leak test at plug (burner must be operating).

"A" MODEL PROCEDURE (with pressure regulator)

1. Check input to main burner by clocking gas meter or by using a pressure gauge (manometer) connected to downstream tapping (Fig. 1). The standard natural gas model is factory set at 3.5 inches wc outlet pressure, and the standard LP gas model is set at 11 inches. If adjustment is required, proceed with step 2.

2. Remove cover screw (see Fig. 1). Using screwdriver, turn adjusting screw clockwise  to increase or counterclockwise  to decrease gas pressure to burner. (Note: Adjustment fitting is plastic and may require slightly greater turning force than metal thread.) Replace cover screw.

"B" MODEL PROCEDURE (no pressure regulator)



1. With main burner off, connect pressure gauge (manometer) to downstream pressure tapping (Fig. 1).

2. With main burner operating, check burner manifold pressure.

3. If pressure is not as specified by the appliance manufacturer, readjust regulator on LP gas storage tank.

STEP-OPENING PRESSURE REGULATOR ("C" MODELS)

1. With main burner operating, check input by clocking gas meter, or check burner manifold pressure using pressure gauge (manometer) connected to downstream pressure tapping (Fig. 1).

2. If adjustment is required, remove cover screw. Using a small screwdriver, turn adjusting screw clockwise  to increase or counterclockwise  to decrease gas pressure to burner. Replace cover screw.

3. Check burner performance at step pressure, observing burner ignition and flame characteristics. Burner should ignite properly and without flashback to orifice, and all ports should remain lit. Cycle burner several times (wait 30 seconds between cycles to allow servo regulator to resume step action.) Repeat after allowing appliance to cool.

CHECKOUT

Put the system into operation and observe through complete cycle to be sure all controls function properly. Make certain the Pilotstat unit shuts off gas flow to main burner within 2-1/2 minutes after pilot flame is extinguished.

PILOT GOES OUT WHEN LITE-RITE KNOB IS RELEASED

1. Check pilot flame adjustment. See page 3.

2. Check the Powerpile generator connection to Pilotstat power unit (Fig. 1). This is an electrical connection and must be clean and secure. Also check the Powerpile generator connections to the valve operator.

3. If power unit still does not hold in, use the W720 Systems Tester to obtain the exact open and closed circuit output voltages of the generator. Compare with the Acceptable Range Charts in W720 manual or Gas Controls Service Handbook. Next check resistance of Pilotstat power unit.

If W720 or other meter is not available, first replace generator. If this does not correct the condition replace power unit (adjacent to gas cock knob — see Fig. 1). Turn off gas supply to appliance (at service cock or meter) and remove power unit with wrench. Install and tighten new power unit. Turn on gas supply and check for gas leakage.

COMPONENT AND PARTS REPLACEMENT

The automatic valve operators and servo regulators may be added in the field, or replaced in service maintenance. (Model number is stamped on side of component.) Complete instructions are furnished with the component.

REPLACEMENT VALVE OPERATOR: VS824A.

REPLACEMENT SERVO PRESSURE REGULATOR:

V5306 standard and V5307 step opening type. Either models are field addable to "B" models.

VS820 "A" or "C" models can be converted to "B" models by removing the pressure regulator and applying a blank plate and gasket, Pt. No. 392782.

REPLACEMENT PARTS:

Pilotstat power unit (750 mv) — 392395.

Compression fitting for pilot tubing connection—
386449.

Pilot gas filter — 391158.

ELECTRICAL DATA:

Pilotstat Power Unit — Hold-in 15 ma maximum;
dropout 10.5 to 4.5 ma; resistance 11 ohms.

Valve Operator — Pull-in 65 ma maximum; coil
resistance 2 ohms.

OPERATING INSTRUCTIONS FOR THE HOMEOWNER

IMPORTANT

Follow the operating instructions provided by the manufacturer of your heating appliance. The information below will be of assistance in a typical control application, but the specific controls used and the procedures outlined by the manufacturer of your appliance may differ, requiring special instructions.

LITE-RITE KNOB SETTINGS

Refer to GAS COCK SETTINGS, page 2.

TO LIGHT PILOT AND TURN ON MAIN BURNER

Follow PILOT LIGHTING PROCEDURE, page 3.

TO SHUT OFF

1. For TEMPORARY situations: Main burner can be shut off by turning clockwise  from ON to PILOT. Pilot will remain lit — ready for return to normal service without relighting. (This is the recommended summer shutdown position.)

2. For COMPLETE SHUTDOWN: Slightly depress Lite-Rite knob when at PILOT position and turn clockwise  to OFF. Both pilot and main burner now are shut off.

AUTOMATIC SAFETY SHUTOFF

The automatic safety shutoff valve blocks gas flow to the main burner and pilot burner if the pilot flame goes out or becomes too small for adequate ignition.

If safety shutoff occurs, check pilot flame after relighting and adjust if necessary. See ADJUST PILOT FLAME, page 3. If shutoff reoccurs, contact your local dealer or gas utility to correct condition causing shutdown.