

# BC-R25 Series Burner Controller User's Manual



Thank you for purchasing the BC-R25 Series. This manual contains information for ensuring the correct use of the BC-R25 Series.

This manual should be read by those who design and maintain equipment that uses the BC-R25 Series.

It also provides necessary information for installation, maintenance, and troubleshooting. Be sure to keep this manual nearby for handy reference.

## **NOTICE**

---

Be sure that the user receives this manual before the product is used.

Copying or duplicating this user's manual in part or in whole is forbidden. The information and specifications in this manual are subject to change without notice.

Considerable effort has been made to ensure that this manual is free from inaccuracies and omissions. If you should find an error or omission, please contact Azbil Corporation.

In no event is Azbil Corporation liable to anyone for any indirect, special or consequential damages as a result of using this product.

---

# Conventions Used in This Manual

---

- To prevent injury to the operator and others, and to prevent property damage, the following types of safety precautions are indicated:



Warnings are indicated when mishandling this product might result in death or serious injury.



Cautions are indicated when mishandling this product might result in minor injury to the user, or physical damage to the product.

- In describing the product, this manual uses the icons and conventions listed below.



Use caution when handling the product.



The indicated action is prohibited.



Be sure to follow the indicated instructions.

## **Handling Precautions:**

Handling Precautions indicate items that the user should pay attention to when handling this module.



## **Note:**

Notes indicate information that might benefit the user.















This indicates the item or page that the user is requested to refer to.

(1)(2)(3)





Numbers within parentheses indicate steps in a sequence or parts of an explanation.

## Safety Precautions

### **WARNING**

	Use this device with combustion equipment that is started and stopped at least once in a 24-hour period.
	This device cannot be used with combustion equipment that operates continuously for 24 hours or longer.
	Before removing, mounting, or wiring the BC-R25 Series, be sure to turn off the power to the BC-R25 Series and all connected devices. Failure to do so might cause electric shock.
	If lockout occurs, reset it only after removing the cause. Also, do not enter reset input repeatedly. Operating this product improperly could result in a serious combustion equipment accident.
	Never input a reset command from a remote location. Because it is difficult to make a safety check when far from the equipment, there is an increased risk of explosion.
	This device is equipped with functions that are extremely important for the safe operation of combustion equipment. Be sure to follow the instructions given in this manual.
	Check the model number carefully and check that the sequence timing is as specified by the combustion equipment manufacturer. Installing the wrong model can result in an explosion hazard.
	Do not touch terminal 14 (F) immediately after the power has been turned off. Because the terminal retains an electrical charge, there is a danger of electric shock.
	Do not use the monitor output or alarm relay output as safety output.
	This device has an operating life and should be replaced within that time. Continued use beyond the lifespan may result in device failure.
	Do not start regular operation of the equipment without first completing the adjustments and tests for this device, as well as the tests specified by the equipment manufacturer.
	Do not disassemble this device. Malfunction, device failure, or electric shock may result.

### **CAUTION**

	In order to use this product correctly, be sure to follow this manual, the manuals for any associated devices, and the manuals for the combustion equipment. When designing a flame safeguard control system, please consult with a representative of the azbil Group.
	Installation, wiring, inspection, adjustment, maintenance, etc. should be carried out only by trained and experienced technicians who have knowledge and technical skills related to this product and associated equipment.
	Be sure to use this device correctly, within the ranges specified in this user's manual. Otherwise device failure or malfunction could result.
	Avoid installing the device where it will be subject to conditions such as the following. Otherwise device failure could result. <ul style="list-style-type: none"><li>• Certain chemicals or corrosive gases</li><li>• High temperatures</li><li>• Splashing water or excessive humidity.</li><li>• Prolonged vibration</li></ul>

## CAUTION



Wire this device in compliance with established norms, using the types of wire and wiring methods specified in this manual. Otherwise there is a risk of device failure or malfunction.



Carry out maintenance and inspection correctly according to the methods, procedures, replacement cycles, etc., specified in this manual.



When discarding this product, dispose of it as industrial waste, following local regulations.



Do not connect a load that exceeds the rating stated in the specifications to the control load terminals (terminals 2-1, 2-6, 2-7, or 2-8), and do not short-circuit the load. Doing so will burn out the internal fuse, making the device unusable. To comply with CE standards, it is necessary to take measures to prevent the use of a device whose relay contacts can be damaged by a connected load that exceeds the rating or by a load short-circuit. For this reason, this device uses an internal fuse that cannot be replaced.

# Contents

---

## Conventions Used in This Manual Safety Precautions

### Chapter 1. Overview

■ Instructions for proper use .....	1
■ Precautions on facility design .....	1
■ Most important points for ensuring safety .....	1
■ Model number .....	2
■ Related equipment .....	3

### Chapter 2. Installation, Wiring

■ Installation method .....	5
■ Cautions regarding installation .....	6
■ Installation orientation .....	6
■ DIN rail mounting .....	6
■ Mounting in a panel .....	7
■ Mounting/removing the device and sub-base (sold separately) .....	7
■ Terminal numbers, front panel item names .....	8
■ Example of wiring connection with external device .....	10

### Chapter 3. Operation

■ Names of parts .....	13
■ Operation .....	13
■ Trial operation mode .....	16
■ Function selection mode (for POC and host communications (RS-485) address).....	18
■ Host communication settings using the Smart Loader Package (SLP-BCR) .....	20

### Chapter 4. Explanation of Operation

■ Example of wiring connection with external device: Internal block diagram .....	21
■ Example sequence .....	23
■ Alarm and occurrence sequence .....	37

### Chapter 5. Trial Operation and Adjustment

■ Preliminary inspection .....	38
■ Inspection procedure .....	38
■ Ignition spark response (UV sensor) .....	39
■ Measurement of flame voltage .....	40
■ Pilot turn-down test .....	42
■ Safety shutoff check .....	43

---

## **Chapter 6. Maintenance and Inspection**

■ General maintenance and inspection .....	44
■ Maintenance and inspection cycle .....	44
■ Alarm codes and details .....	45
■ Failure inspection flow .....	46

## **Chapter 7. Specifications**

■ External dimensions .....	49
-----------------------------	----





# Chapter 1. Overview

BC-R25 burner controllers are designed for batch operation of combustion equipment (at least one start and stop in a 24-hour period). The BC-R25 automatically executes ignition, flame monitoring, and fuel shutoff for ON/OFF-controlled gas burners and oil burners. Its features include a 7-segment LED display that is useful for maintenance and a test mode that is convenient for trial runs & adjustment. In addition, it is equipped with host communication (RS-485) and Smart Loader Package compatibility, which make more detailed monitoring and troubleshooting possible.

- 7-segment display for sequence codes and alarm codes.
- LED indicators show whether there is a flame signal and whether lock-out is present.
- The monitor outputs the operating status of the flame signal, ignition failure, flame failure and lock-out interlock.
- Perform fault diagnosis for the internal control relay circuit.
- The product is designed so that it cannot be restarted in the case of lock-out due to ignition failure, false flame or other causes, unless it is reset manually.
- The design complies with JIS C 9730-2-5 and JIS C 9730-1.
- The air-flow switch (OFF/ON) is checked before and after start check. (JIS B 8407)
- POC (proof of closure) function based on shutoff valve closure confirmation switch input.
- Host communication (RS-485) allowing remote observation of status
- DIN rail mounting and sub-base structure are provided for easy installation and replacement

## ■ Instructions for proper use

- This device has functions that are extremely important for the safe operation of combustion equipment. Therefore, use the device correctly, according to this user's manual.
- The device must be installed, wired, maintained, inspected and adjusted by experienced specialists who have gained knowledge and skills concerning combustion equipment and combustion safety devices.

## ■ Precautions on facility design

The facilities that use the combustion safety device must be designed taking into careful consideration the following safety guidelines and the like.

If the system is designed to a foreign specification, refer to laws and standards in the relevant country.

- “Technical Policy on Safety Standards for Combustion Equipment in Industrial Furnaces,” by the Ministry of Health, Labour and Welfare
- “General Safety Code for Industrial Combustion Furnaces” - JIS B 8415
- “Forced Draught Burners - Part 1: Gas Burners” - JIS B 8407-1
- “Forced Draught Burners - Part 2: Oil Burners” - JIS B 8407-2
- “Index of Safety Technology of Industrial Gas Combustion Equipment,” by Japan Gas Association
- “Safety Guideline for Gas Boiler Combustion Equipment” by The Japan Gas Association

## ■ Most important points for ensuring safety

The design must take into consideration the following points to ensure safety.

1. Connect loads directly to the device.
2. Make sure that the start check circuit operates correctly at startup.
3. Do not make a manual operation circuit or other bypass circuit for any loads.
4. Use a redundant shutdown system for both main valve and pilot valve.

## ■ Model number

(Note: The dedicated sub-base and sideboard are not provided with the BC-R25 series controller. Order them separately.)

### ● Direct ignition type

I II III IV V VI VII Example: BC-R25B1J0500

I	II	III	IV	V	VI	VII	Description
Base model number	Commu- nications function	Flame detector	Power supply	Function code	Timing Code	Additional functions	
BC-R							Burner Controller
	25						RS-485, with Smart Loader Package function
		B					Flame rod (Ionization)
		C					UV sensor (AUD100/110)
			1				100 Vac
			2				200 Vac
			6				220 Vac
				J			Direct ignition type
					050		Pre-purge time 35 s
					086		Pre-purge time 45 s
					122		Pre-purge time 60 s
					158		Pre-purge time 3 min
						0	None
						D	With inspection record (with data)

### ● Interrupted pilot type

I II III IV V VI VII Example: BC-R25B1G0500

I	II	III	IV	V	VI	VII	Description
Base model number	Commu- nications function	Flame detector	Power supply	Function code	Timing Code	Additional functions	
BC-R							Burner Controller
	25						RS-485, with Smart Loader Package function
		B					Flame rod (Ionization)
		C					UV sensor (AUD100/110)
			1				100 Vac
			2				200 Vac
			6				220 Vac
				G			Interrupted pilot type
					050		Pre-purge time 35 s
					086		Pre-purge time 45 s
					122		Pre-purge time 60 s
					158		Pre-purge time 3 min
						0	None
						D	With inspection record (with data)

## ■ Related equipment

### ● Compatible flame detector (sold separately)

#### • Flame detector UV sensor

Model number	Name	Notes
AUD15C1000	Advanced UV sensor Tube unit	Use a dedicated socket for the AUD100C/110C/120C
AUD100C100_	Advanced UV flame detector (Lead wire model without AUD15C)	AUD15C1000, sold separately
AUD100C1000-A15	Advanced UV flame detector (Lead wire model with AUD15C)	AUD15C1000 in package
AUD110C100_	Advanced UV flame detector (Terminal block model without AUD15C)	AUD15C1000, sold separately
AUD110C1000-A15	Advanced UV flame detector (Terminal block model with AUD15C)	AUD15C1000 in package
AUD120C120_	Advanced UV flame detector (1/2-inch mounting model)	Without G1/2 adapter, AUD15C1000, sold separately
AUD120C121_		With G1/2 adapter, AUD15C1000, sold separately

\_ : 0: standard product. D: with inspection record (with data).

T: tropicalization (AUD110C only).

B: inspection record (with data) and tropicalization (AUD110C only).

#### • Flame rod





Model number	Name	Notes
C7007A	Flame rod holder	
C7008A	Flame rod assembly	

### ● Optional parts (sold separately)

Model number	Product name	Notes
BC-R05A100	Dedicated sub-base for BC-R	Required for all products in the BC-R25 series
81447514-001	Connector for front wiring	Contains one Weidmueller model number : BL3.5/11F Compatible wire: 0.2–1.5 mm <sup>2</sup> (28–14 AWG)
81447514-002	Connector for front wiring (for right-side wiring)	Contains one Weidmueller model number : BL3.5/11/270F Compatible wire: 0.2–1.5 mm <sup>2</sup> (28–14 AWG)
81447515-001	Side boards (2)	Contains two Not included in the sub-base
SLP-BCRJ71	Smart Loader Package (no cable)	Compatible with BC-R25 (with communications functions)
81441177-001	USB loader cable	
FSP136A100	Analog flame meter	
81447519-001	Jack cover	Contains one
81447531-001	Front connector cover	Mounting screw supplied

# Chapter 2. Installation, Wiring

## **WARNING**

-  Never input a reset command from a remote location. Because it is difficult to make a safety check when far from the equipment, there is an increased risk of explosion.
-  This device is equipped with functions that are extremely important for the safe operation of combustion equipment. Be sure to follow the instructions given in this manual.
-  Check the model number carefully and check that the sequence timing is as specified by the combustion equipment manufacturer. Installing the wrong model can result in an explosion hazard.
-  Connect the load (ignition transformer, solenoid valve, etc.) directly to the output terminals of this device.  
If it is not directly connected, combustion safety cannot be ensured.

## **CAUTION**

-  A ground-fault detection circuit is included in this device. Even if the power supply does not have high and low potential sides, if a ground fault occurs due to insulation failure of a load such as an ignition transformer, pilot valve, or main valve, this device will detect the ground fault and safely shut off and lock out the equipment.
-  When mounting and wiring, be sure to follow this user's manual or the instruction manuals provided by the equipment or system manufacturer.
-  Carry out the wiring work in conformity with the specified standards.
-  Connect the power supply last to prevent electric shock or damage. Otherwise touching terminals by mistake may cause electric shock or may damage the device.
-  Make sure that loads connected to the terminals do not exceed the rating indicated in the specifications.
-  Supply power at the voltage and frequency indicated on the model number label of the device.
-  In keeping with technical standards for electrical equipment, the burner frame must be connected to an earth ground by a wire having a resistance of less than 100  $\Omega$ .
-  Run the high-voltage ignition transformer cable separately and keep it at least 30 cm away from this device.
-  Keep power lines and ignition transformer high-voltage cables separate from the flame detector wires.
-  Make sure that ignition transformer high-voltage cables are properly connected to prevent faulty contact. Faulty contact can generate high-frequency radio waves, causing malfunction.
-  The ignition transformer ground lead should be connected directly to the burner itself or to a metallic part electrically connected to the burner.
-  Be sure to check that the wiring is correct before you turn the power ON. Incorrect wiring can cause damage or malfunction.
-  If the wires from this device exceed the recommended length, to prevent malfunction due to external electrical noise, keep power wiring away from the wires running from the control panel to the burner controller. After wiring, check that the equipment is operating properly.
-  Be sure to connect non-voltage contacts to the inputs of this device (terminals 16 to 29).
-  After the power has been turned ON, leave sufficient time before checking the output. This device does not operate for about 8 seconds after the power has been turned ON.

**⚠ CAUTION**

- ⚠ The reset input (terminal 24) must be used by this device only. It cannot be shared with any other BC-R unit.
- ⚠ Output common terminals 4 and 5, and input common terminals 16 and 17 cannot be shared with any other BC-R unit.
- ⚠ Do not design instrumentation that shuts off the power to this device as soon as alarm output is generated. Doing so can corrupt this device's operation history records.
- ⚠ To prevent malfunction due to external electrical noise, do not operate the device with the loader cable except for trial runs, maintenance, and troubleshooting.
- ⚠ If there is an inverter or the like that generates strong electrical noise near this device, take noise-suppression measures, referring to the user's manual for the noise-generating equipment.

**■ Installation method****⚠ WARNING**

- ⚠ Ensure you turn off the power of this device and all auxiliary devices when mounting, removing or connecting the wires of this device. There is a risk of electrical shock.

**⚠ CAUTION**

- ⚠ Mounting, wiring, maintenance, inspection, calibration, etc. should be carried out by a professional with technical training in combustion systems and flame safeguard control devices.
- ⚠ Do not install where exposed to any of the following:
  - Certain chemicals or corrosive gases (ammonia, sulfur, chlorine, ethylene compounds, acids, etc.)
  - Dripping water or excessive humidity
  - High temperatures
  - Sustained long-term vibration
- ⚠ For mounting and wiring, follow the instructions in this user's manual or in the combustion equipment manufacturer's manual.
- ⚠ A fuse is built into the control load line of this device. Do not short-circuit the load, or the fuse will melt. If the fuse has melted, replace the device.
- ⚠ When using the device as a burner control system, install it to a control panel that supports IP40 or more. If IP40 is required for this single device, also use a side board (sold separately). The protection structure of the device is equivalent to IP10.

### ■ Cautions regarding installation

- Take space 50 mm above and below, 50 mm to the left and right, and 80 mm to the front, as **space for removal, wiring, and maintenance**. Also, do not install this device close to electric power devices or other sources of heat.

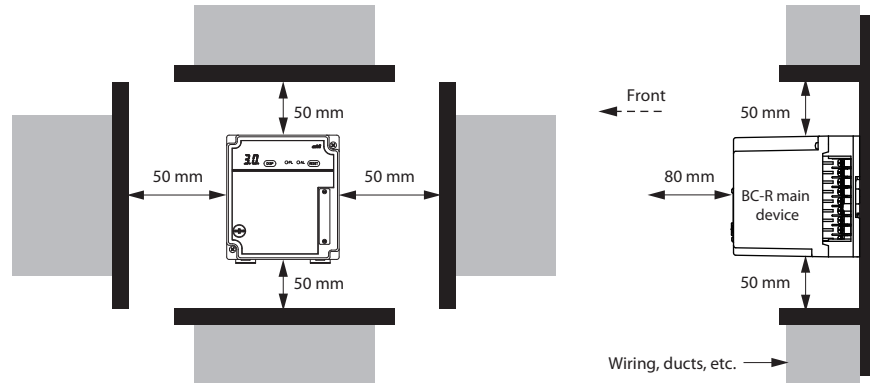

- This device must be grounded within a grounded and conductive control panel to ensure safety.
- Do not pull the wiring while it is attached to the device. Doing so can cause failures of the connectors or the device itself.

### ■ Installation orientation

Attach the device in the orientation shown below.



Do not install it in the orientations illustrated below.

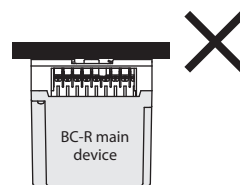

### ■ DIN rail mounting

- (1) Pull down the sub-base's DIN rail clamp.
- (2) Attach to the DIN rail while checking above and below the sub-base.
- (3) Push up the DIN rail clamp to attach the sub-base to the DIN rail.

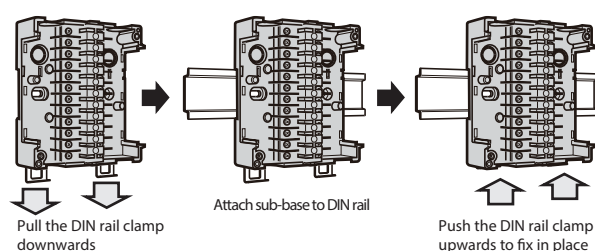

### ■ Mounting in a panel

- (1) Drill two M4 screw holes into the panel.

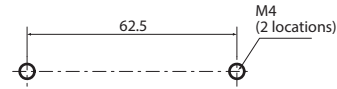

(Unit: mm)

- (2) Use screws to mount the sub-base on the panel.  
(Maximum tightening torque: 1.2 N·m)

## ⚠ CAUTION



Turn the power off before mounting the device on the sub-base. Otherwise, device failure may occur.

### ■ Mounting/removing the device and sub-base (sold separately)

(Mounting)

- (1) Align the indentation in the center of the top of the device with the projection on the sub-base.

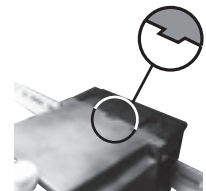

- (2) Once aligned as in (1), push straight downwards slowly.



- (3) Tighten the device's retaining screws to secure it in the sub-base. (Maximum tightening torque: 0.5 N·m)



(Removal)

- (1) Remove the retaining screws from the device.  
(2) Pull it out horizontally while holding down the sub-base.



■ Terminal numbers, front panel item names

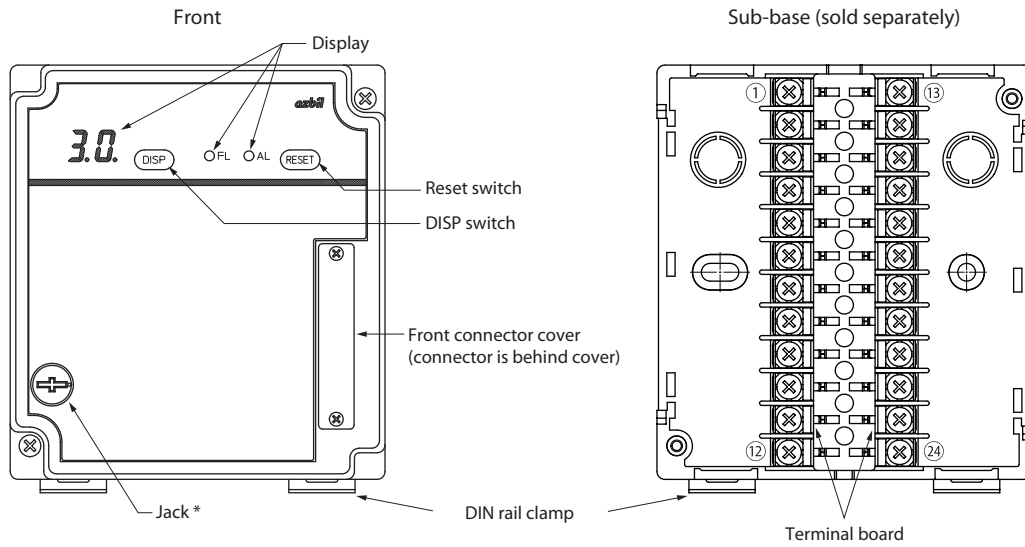

\* Set the POC function as disabled  
On BC-R25, also used as a Smart Loader Package jack

● Terminal No.

Front connector terminals

No.	Function	No.	Function
25	Flame voltage output (+)	31	Power supply for monitor output
26	Flame voltage output (-)	32	Monitor output, flame
27	Host communications (RS-485) DA	33	Monitor output, ignition failure
28	Host communications (RS-485) DB	34	Monitor output, flame failure
29	Host communications (RS-485) SG	35	Monitor output, lock-out interlock
30	NC	-	-

Sub-base terminals

No.	Function	No.	Function
1	Blower motor output (electromagnetic breaker)	13	Alarm output
2	AC power supply (L1)	14	Flame detector (F)
3	AC power supply (L2 (N))	15	Flame detector (G)
4	Output common 1	16	Input common 1
5	Output common 2	17	Input common 2
6	Ignition transformer output	18	NC
7	Pilot valve output	19	NC
8	Main valve output	20	Start input
9	NC	21	Air-flow switch input
10	NC	22	Lock-out interlock input
11	NC	23	POC (proof of closure) input
12	NC	24	Contact reset input



● Connector for front wiring (81447514-001) terminal layout

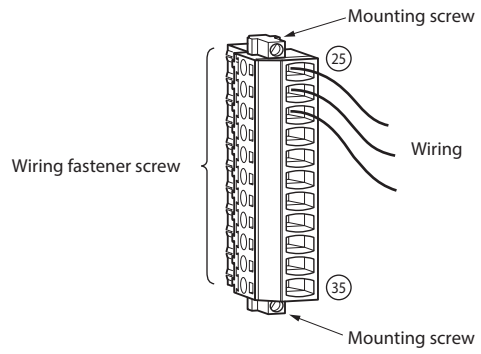

● Connector for front wiring (for right side wiring) (81447514-002) terminal layout

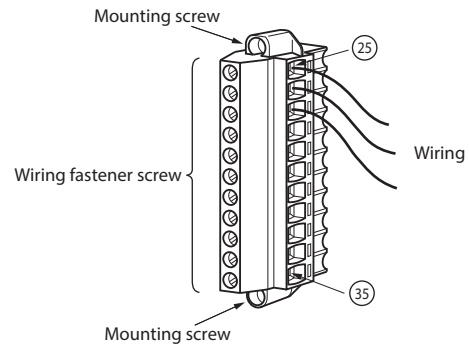

■ Example of wiring connection with external device

(Terminals 1 to 24: sub-base. Terminals 25 to 35: front connector.)

● Interrupted pilot type

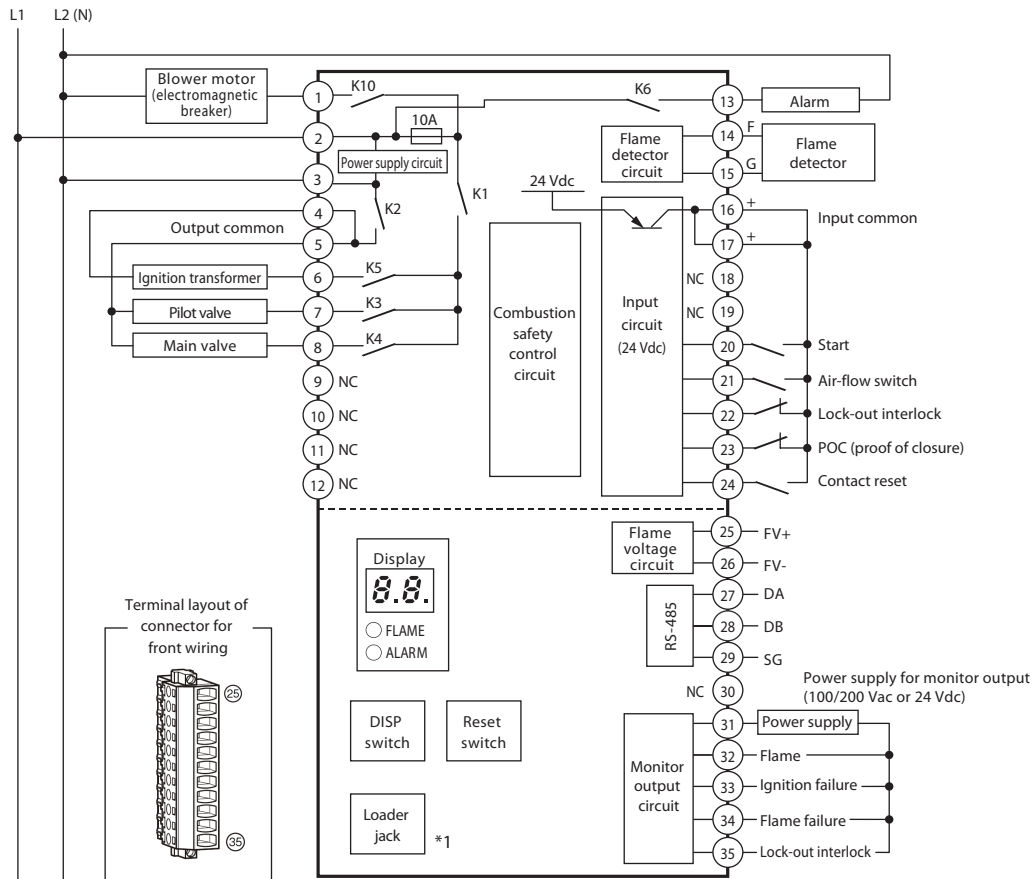

● Direct ignition type

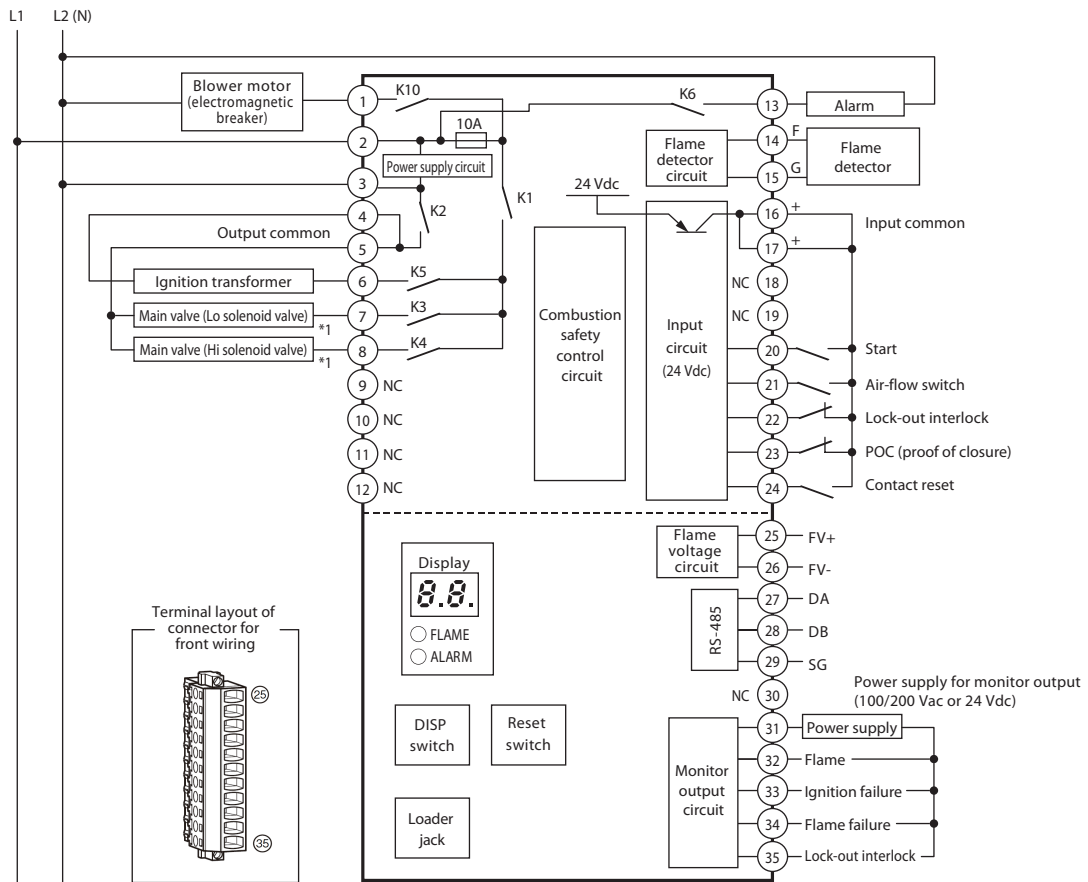

Notes

- Use contact reset (terminal 24) input in isolation. It cannot be used in conjunction with other BC-R contact reset inputs.
  - Output common (terminals 4, 5) and input common (terminal 16, 17) cannot be used in conjunction with other BC-R.
- \*1 Content in ( ) describes the situation when three-position (Off-Lo-Hi) control is used. If other than three-position control is used, connect to main valve (terminal 7).

● **Wiring to a flame detector (UV sensor)**

• AUD100C+AUD15C

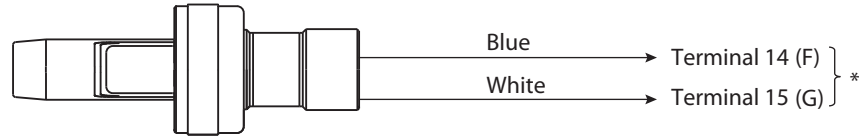

• AUD110C+AUD15C

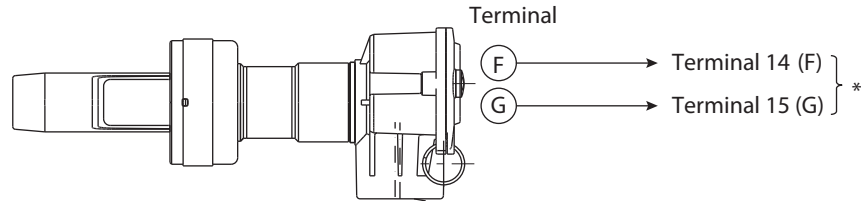

• AUD120C+AUD15C

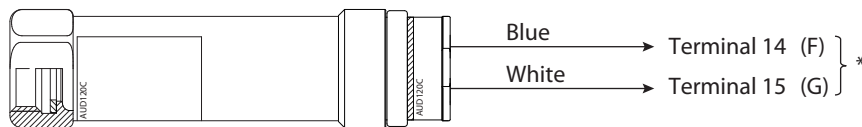

\* If connection of the blue and white lead wires is reversed, or if the connections to terminals (F) and (G) are reversed, the AUD15C tube unit may be damaged.

● **Wiring to a rectification flame rod**

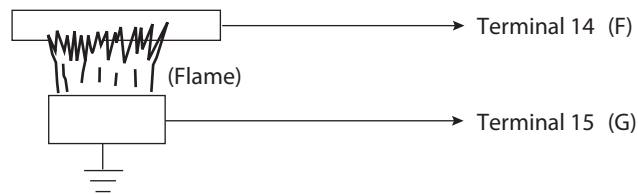

● **Example countermeasures against power surges caused by lightning**

When using a line surge suppressor as a countermeasure against power surges caused by lightning, connect it between Terminal 3 and the ground, as shown below.

The mounting brackets of the surge suppressor are crimp-on at the grounded side and inside and in conducting state.

Therefore, they can be grounded by simply attaching them to a grounded metal part such as the device cabinet.

When wiring to the power supply, use a lead wire of 0.75mm<sup>2</sup> (diameter: 0.18, strand count: 30) or more, which complies with JIS C 3306. Attach #187 Faston receptacle at one end and make the wire length as short as possible when connecting it.

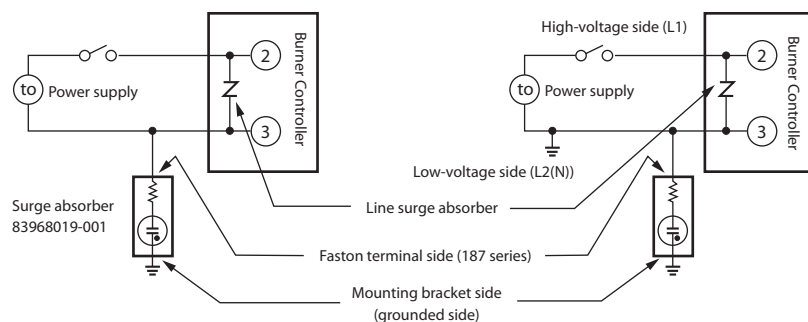

# Chapter 3. Operation

## Names of parts

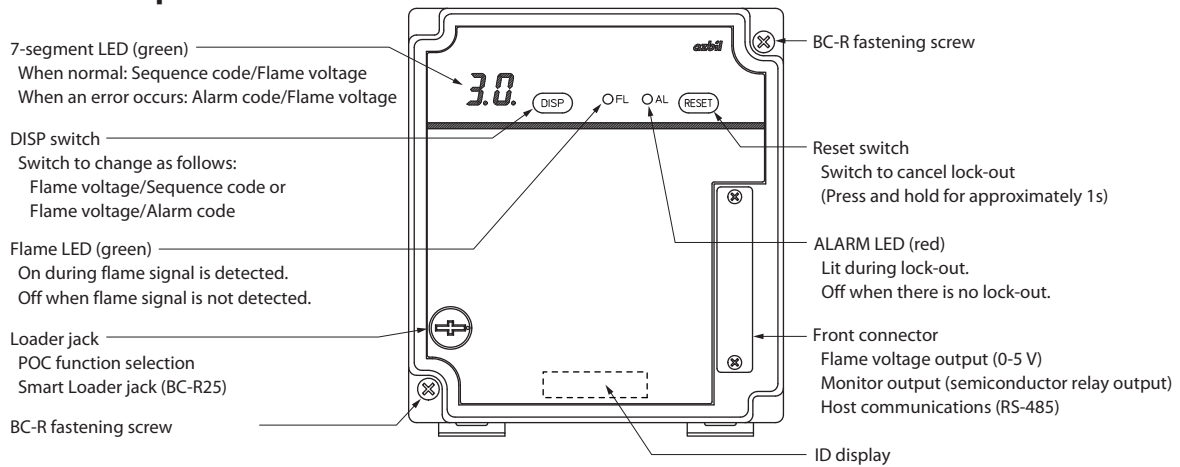

When a lock-out occurs, an alarm code is displayed automatically.

When an alarm occurs, the sequence code and alarm code issued when the lock-out occurred are displayed alternately.

### ID display

Item	Notation
• Product number	BC-R25xxxxxxx
• Voltage	AC xxx V
• Flame detector (UV sensor)	UV
(Flame rod)	Ionization
• Timing display	Pre-purge time
	Ignition trial
	Trial time
	Flame failure response time
	PPT xx s
	IGT xx s
	FFRT xx s

## Operation

### ● Operation switch

#### During normal operation

The 7-segment display shows a sequence code.

Every time the DISP switch is pressed, the display is changed between the sequence code and flame voltage alternately.

#### Sequence codes

Code	Interrupted pilot type	Direct ignition type
P1	Start check	
P2	Pre-purge	
P4	Ignition trial	Ignition trial
P5	Pilot stabilization	Hi-valve ignition standby
P6	Main trial	Hi-valve ignition
P8	RUN	
P9	Post-purge	
--	Controlled shutdown	

**When an error occurs**

The 7-segment display shows a alarm code and the sequence code for which the alarm was issued alternately.

Every time the DISP switch is pressed, the display is changed between a alarm code and the sequence code for which the alarm was issued alternately as well as the flame voltage.

**Alarm codes**

Alarm codes	Sub-code	Description
E0	None	interlock error
E1		False flame
E2		Air-flow switch error (1)
E3		Air-flow switch error (2)
E6		Ignition failure
E7		Flame failure
E8		POC (proof of closure) error *
E9		02
E9	03	Internal relay feedback (K1)
E9	04	Terminal 4 and 5 voltage discrepancy (K2)
E9	05	Terminal 7 voltage discrepancy (PV)
E9	06	Terminal 8 voltage discrepancy (MV)
E9	07	Terminal 6 voltage discrepancy (IG)
E9	08	Alarm activation at power ON
E9	50 or more	Device error

\* Replace the burner controller, and if there is a alarm code E8, POC may have been set by the equipment manufacturer as disabled.

In this case, check the equipment specification, and refer to “Function Setup Mode” on P. 18 if necessary.

**Examples of sequence codes and alarm codes (Alarm code: E0-E8)**

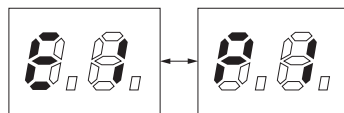

Switches every 0.8 s

**Examples of sequence codes and alarm codes (Alarm code: E9 + sub-code (2 digits))**

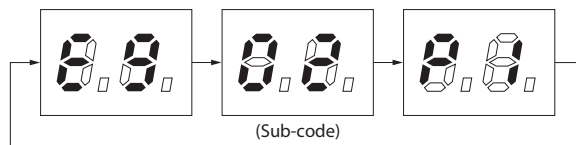

Switches every 0.8 s

● **Reset switch** \*

Lock-out is canceled when the reset switch is pressed and held for 1 s.

\* After the lock-out is canceled, a stabilization time of approximately 5 seconds should be maintained.

During the stabilization time, no start input can be accepted.

- During postpurge, reset is not possible.

## ■ Trial operation mode

### ⚠ WARNING



Loads (the blower, ignition transformer, valves, etc.) operate in trial operation mode. They should be operated by a person with expert knowledge and an understanding of the functions. There is a risk of a major accident.

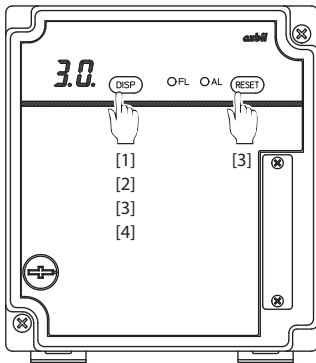

Transition to trial operation mode

- [1] Press and hold the DISP switch for approximately 5s or more during the stop sequence (when the start input is Off).  
The 7-segment display changes to [  $\text{E}1$  ] and the system goes into trial operation mode.  
The central dot of the 7-segment display starts blinking (on a 1 s cycle).

- [2] Each time the DISP switch is pressed, the display cycles through the sequence [  $\text{E}1 \rightarrow \text{E}2 \rightarrow \text{E}3 \rightarrow \text{E}4 \rightarrow \text{E}5 \rightarrow \text{E}6$  ].

Display	Description
$\text{E}1$	Continuous pilot burn mode (only output from the main valve 1 with direct ignition)
$\text{E}2$	Monitor output, flame
$\text{E}3$	Monitor output, ignition failure
$\text{E}4$	Monitor output, flame failure
$\text{E}5$	Monitor output, lock-out interlock
$\text{E}6$	Blower output

Trial operation setup

#### • Selecting trial operation mode

- [3] Select a trial operation type using the DISP switch.

When  $\text{E}1$  is selected

- 1 Press the Reset button when  $\text{E}1$  is displayed.  
The 7-segment display shows [ - - ] blinking.
- 2 The combustion sequence starts when start input is received.  
At that stage, the sequence code blinks. (It is steadily lit in normal mode.)

When  $\text{E}2$ - $\text{E}6$  is selected

- 1 Press the Reset button to enter selection mode.  
The 7-segment display shows [  $\text{E}x/\text{OF}$  ].
- 2 When the DISP switch is pressed in this situation, the display toggles between [  $\text{E}x/\text{OF}$  ] and [  $\text{E}x/\text{ON}$  ], and trial operation runs according to the On/Off selection.

\* $\text{E}6$  only becomes [  $\text{E}6/\text{ON}$  ]. To turn the blower off, press the Reset switch when in this state.

- 3 When the Reset switch is pressed to stop trial operation, the display for selecting types of trial operation ([2] above) is displayed.



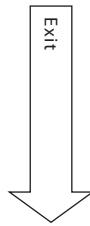

[4] Press and hold the DISP switch for 5 s or more to end trial operation mode.

Trial operation mode also ends in the following situations.

- Power OFF
- Alarm is issued during trial operation mode (in continuous pilot burn mode).

### 1.1 Continuous pilot burn mode (㉔)

In the combustion sequence, only the pilot burns and main trial is not performed.

A lock-out occurs if there is an error.

### 1.2 Forced flame monitor output (㉕)

This function forces the monitor output to perform output to check the operations of indicators and other components that are connected to the monitor output terminal.

Forces the monitor output (flame) ON or OFF.

### 1.3 Forced ignition failure monitor output (㉖)

This function forces the monitor output to perform output to check the operations of indicators and other components that are connected to the monitor output terminal.

Forces the monitor output (ignition failure) ON or OFF.

### 1.4 Forced flame failure monitor output (㉗)

This function forces the monitor output to perform output to check the operations of indicators and other components that are connected to the monitor output terminal.

Forces the monitor output (flame failure) ON or OFF.

### 1.5 Forced lock-out interlock monitor output (㉘)

This function forces the monitor output to perform output to check the operations of indicators and other components that are connected to the monitor output terminal.

Forces the monitor output (lock-out interlock) ON or OFF.

### 1.6 Blower motor (electromagnetic breaker) output On (㉙)

This function enables the blower to output in order to check the air volume.

■ Function selection mode (for POC and host communications (RS-485) address)

**CAUTION**

- ❗ If POC is selected, the lower right dot of the 7-segment display is lit, regardless of the operation mode. If devices installed in the system are set without selecting POC (proof of closure), an E8 error is issued when this device is replaced, unless the new device is set without POC (proof of closure) selection.
- ❗ In regular modes other than function selection mode, remove the dedicated pin plug.

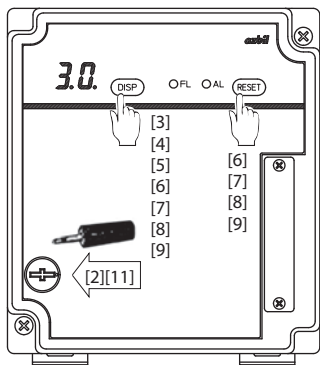

Transition to function setting mode

- [1] Turn the power Off.
- [2] Insert the dedicated pin plug into the loader jack connector.
- [3] Turn on the power while holding the DISP switch down (approx. 10 seconds).  
The 7-segment display shows a blinking [H-], (with a blink cycle of 0.4 seconds) and ALARM LED blinks (on a 1 s blink cycle).
- [4] Release the DISP switch, then press and hold it again for at least 5 s.  
The 7-segment display shows [H!], and the mode switches to function selection mode. (The ALARM LED continues to blink)

❗ If the 7-segment display flashes [σ-/-σ] for 2.5 s, the transition to function selection mode has not succeeded. The pin plug may not be inserted correctly.

- [5] Each time the DISP switch is pressed, the display cycles through the sequence [ → H1 → H2 → H3 → H4 ].

Display	Description
H1	POC (proof of closure) selection settings
H2	Communications address setting
H3	Baud rate setting
H4	Communications format setting

Various settings

• POC (proof of closure) action selection setting

- [6] Use the DISP switch to select 7-segment display [H!].

- 1 Press the Reset button.  
The 7-segment display shows [H!oF] or [H!on].
- 2 When the DISP switch is pressed in this situation, the display toggles between [H!oF] and [H!on], and the POC action selection is changed between On and Off.

ON	POC function enabled
OFF	POC function disabled

- 3 After making the selection, press the Reset switch to confirm the setting.

If On (with POC function enabled) is selected at this stage, the display is [H!].

While the POC function is active, a dot appears in the lower right area of the 7 segment display.

While the POC function is inactive, [H!] is active, and no dot appears in the lower right area of the 7 segment display.

• Factory settings

Settings
ON: POC function enabled

## • Factory settings

Settings
1

## • Factory settings

Settings
3: 19600 bps

## • Factory settings

Settings
1: Even parity 1 stop bit

Various settings

## • Communications address setting (only on the BC-R25)

[7] Use the DISP switch to select 7-segment display [ $\mathcal{H}2$ ].

- 1 Press the Reset button. (On the BC-R25, pressing this does not change the display).  
The 7-segment display shows [ $\mathcal{H}2/xx$  ], where XX is the address value.
- 2 When the DISP switch is pressed in this situation, the display toggles between [ $\rightarrow \mathcal{H}2/1 \rightarrow \mathcal{H}2/2 \rightarrow \mathcal{H}2/3 \dots \dots \mathcal{H}2/32$  ].  
Make the address selection.
- 3 After making the selection, press the Reset switch to confirm.  
At this stage, the display is [ $\mathcal{H}2$ ].

## • Baud rate setting (only on the BC-R25)

[8] Use the DISP switch to select 7-segment display [ $\mathcal{H}3$ ].

- 1 Press the Reset button. (On the BC-R25, pressing this does not change the display).  
The 7-segment display shows [ $\mathcal{H}3/xx$  ], where XX is 1-3 1:  
1: 4800 bps  
2: 9600 bps  
3: 19200 bps
- 2 When the DISP switch is pressed in this situation, the display cycles through [ $\rightarrow \mathcal{H}3/1 \rightarrow \mathcal{H}3/2 \rightarrow \mathcal{H}3/3$  ].  
Make the baud rate selection. ]
- 3 After making the selection, press the Reset switch to confirm.  
At this stage, the display is [ $\mathcal{H}3$ ].

## • Communications format setting (only on the BC-R25)

[9] Use the DISP switch to select 7-segment display [ $\mathcal{H}4$ ].

- 1 Press the Reset button. (On the BC-R25, pressing this does not change the display).  
The 7-segment display shows [ $\mathcal{H}4/xx$  ], where XX is 1-4  
1: Even parity, 1 stop bit  
2: Even parity, 2 stop bits  
3: Odd parity, 1 stop bit  
4: Odd parity, 2 stop bits
- 2 When the DISP switch is pressed in this situation, the display cycles through [ $\rightarrow \mathcal{H}4/1 \rightarrow \mathcal{H}4/2 \rightarrow \mathcal{H}4/3$  ].  
Select the communications format. ]
- 3 After making the selection, press the Reset switch to confirm.  
At this stage, the display is [ $\mathcal{H}4$ ].

[10] Turn the power Off.

[11] Remove the pin plug.

Exit

---

## ■ Host communication settings using the Smart Loader Package (SLP-BCR)

Function setting mode [M2], [M3] and [M4] (host communication (RS-485) setting) can also be set using the smart loader package.

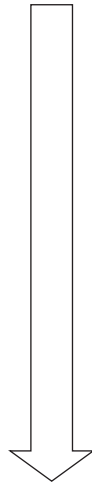

- [1] Turn off the power of the product.
- [2] Remove the wiring of RS-485.  
Insert one end of the USB loader cable into the loader jack of the product, and then insert the other end into a USB port of the PC.
- [3] Turn on the power of the product.
- [4] Start SLP-BCR and set host communication.  
(Do not turn off the power for 5 seconds after pressing the [Set] button, as data is being written.)
- [5] Turn off the power of the product.  
Remove the USB loader cable.  
Connect RS-485.
- [6] Turn on the power of the product.
- [7] Start communications with the host device.

# Chapter 4. Explanation of Operation

## ⚠ CAUTION

- ❗ Even if the start input is turned on, this device does not begin operation until approximately 8 seconds after power supply being turned on. Therefore, give sufficient time after turning on the power, then check the output of the device.
- ❗ As the start input uses a 24 Vdc input circuit, it takes approximately 1 second to confirm it.

### ■ Example of wiring connection with external device: Internal block diagram

(Terminals 1 to 24: sub-base. Terminals 25 to 35: front connector.)

#### ● Interrupted pilot type

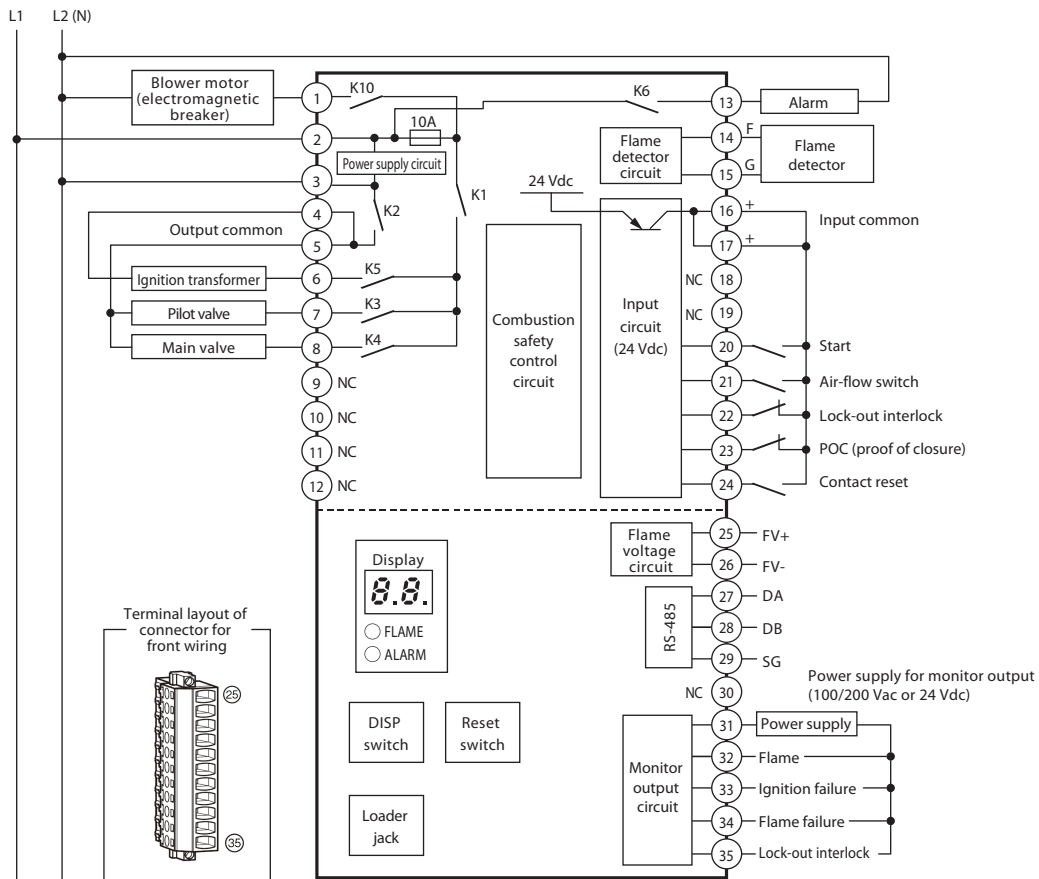

● Direct ignition type

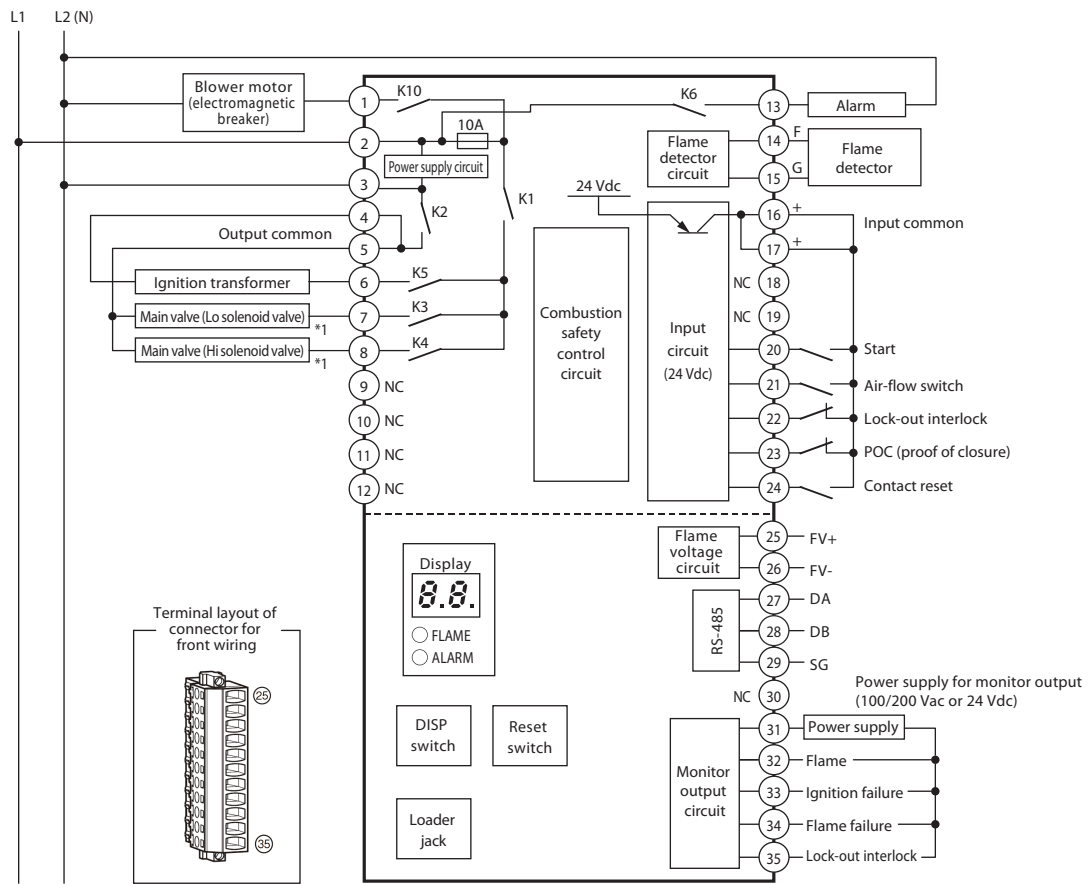

\*1 Content in ( ) describes the situation when three-position (Off-Lo-Hi) control is used. If other than three-position control is used, connect to main valve (terminal 7).

! Handling Precautions

- POC (proof of closure) is checked in synchronization with the operation of the main valve for the interrupted pilot type, or the operation of the Lo solenoid valve (main valve) for the direct ignition type.

■ Example sequence

- Normal operation
  - Interrupted pilot type

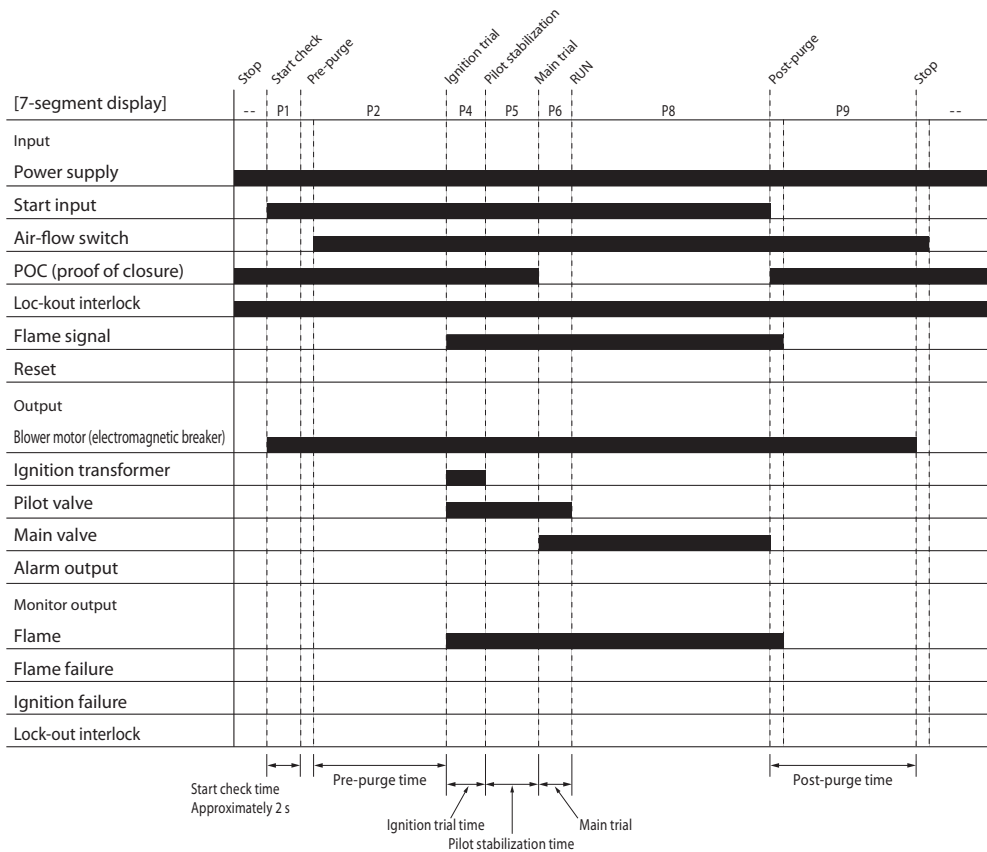

Input	Action	Sequence codes
Start input ON	When the start input is turned ON, the internal circuits are checked, and also checks are done to make sure that lock-out interlock is ON (normal), that the shutoff valve proof of closure switch is ON (POC function enabled), and that the air-flow switch is OFF. K10 is turned ON and the blower motor is turned ON.	P1
	The air-flow switch remains ON with the pre-purge timing.	P2
	After the pre-purge time has elapsed, K3 and K5 are turned ON to perform the output of the ignition transformer and pilot valve.	P4
	When the ignition trail time has elapsed, K5 is turned OFF and the ignition transformer is turned OFF.	P5
	K4 is turned ON and the main valve is turned ON. Within 3 seconds after the main valve is turned ON a check is done to make sure that the shutoff valve proof of closure switch is OFF (POC function enabled).	P6
	Once the main trail is completed, K3 is turned OFF and the pilot valve is turned OFF. RUN sequence continues in this state until the start input is turned OFF.	P8
Start input OFF	When the start input is turned OFF, K1, K2, and K4 are turned OFF and the main valve is turned OFF. K10 remains turned ON to keep the blower ON.	P9
	After the post-purge time has elapsed, K10 is turned OFF, the blower motor is turned OFF, and the system stands by until the next start input is turned ON. Also, when the start input is OFF, lock-out interlock, shutoff valve proof of closure check, and lock-out due to false flame are not performed. However, the flame of monitor output is generated if the flame detector detects a flame.	-

● Normal operation

• Direct ignition type

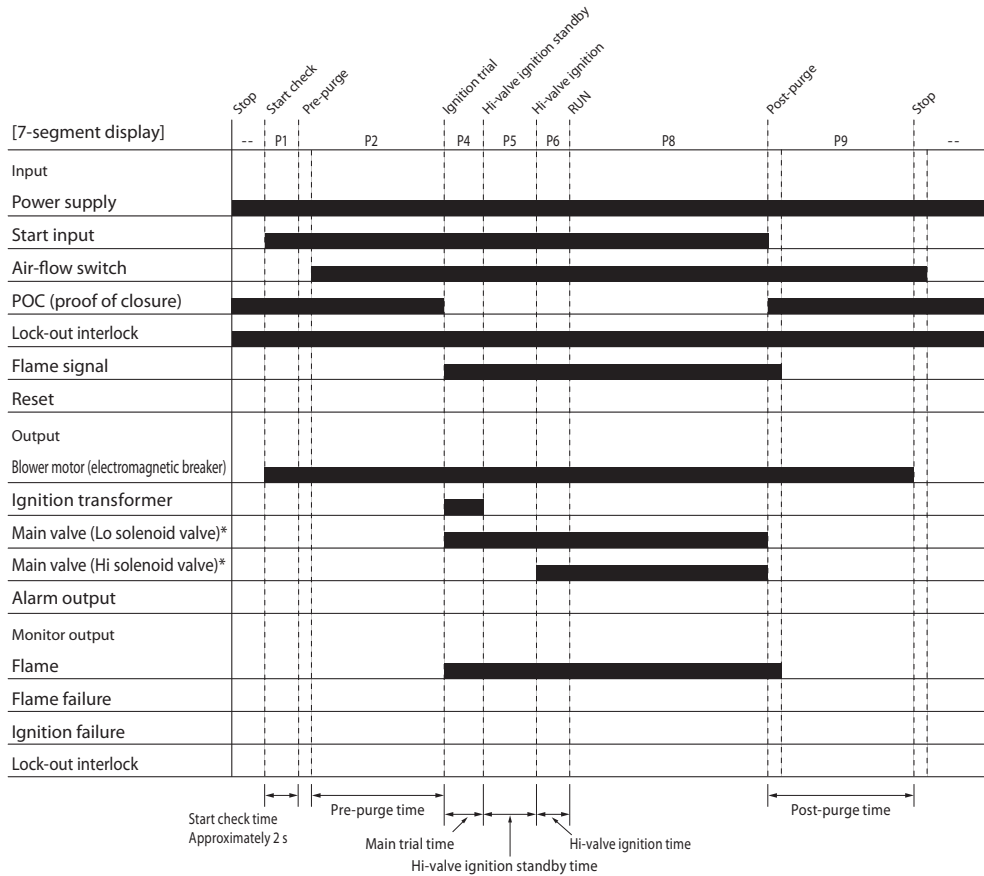

\* Content in ( ) describes the situation when three-position (Off-Lo-Hi) control is used. If other than three-position control is used, only look at the main valve (Lo solenoid valve)

Input	Operation	Sequence codes
Start input ON	When the start input is turned ON, the internal circuits are checked, and also checks are done to make sure that lock-out interlock is ON (normal), that the shutoff valve proof of closure switch is ON (POC function enabled), and that the air-flow switch is OFF. K10 is turned ON and the blower motor is turned ON.	P1
	The air-flow switch remains ON with the pre-purge timing.	P2
	After the pre-purge timing is completed, K3 and K5 are turned ON to perform the output of the ignition transformer and main valve (Lo solenoid valve). Within 3 seconds after the main valve is turned ON a check is done to make sure that the shutoff valve proof of closure switch is OFF (POC function enabled).	P4
	When the ignition trail time is reached, K5 is turned OFF and the ignition transformer is turned OFF.	P5
	K4 is turned ON and Hi solenoid valve is turned ON.	P6
Start input OFF	Even after the completion of Hi solenoid valve ignition, K3 and K4 are turned ON, and both Lo solenoid valve and Hi solenoid valve remain turned ON. RUN sequence continues in this state until the start input is turned OFF.	P8
	When the start input is turned OFF, K1, K2, and K4 are turned OFF and the main valve is turned OFF. K10 remains turned ON to keep the blower ON.	P9
	After the post-purge time has elapsed, K10 is turned OFF, the blower motor is turned OFF, and the system stands by until the next start input is turned ON. Also, when the start input is OFF, lock-out interlock, shutoff valve proof of closure check, and lock-out due to false flame are not performed. However, the flame of monitor output is generated if the flame detector detects a flame.	-



● No ignition

- Interrupted pilot type

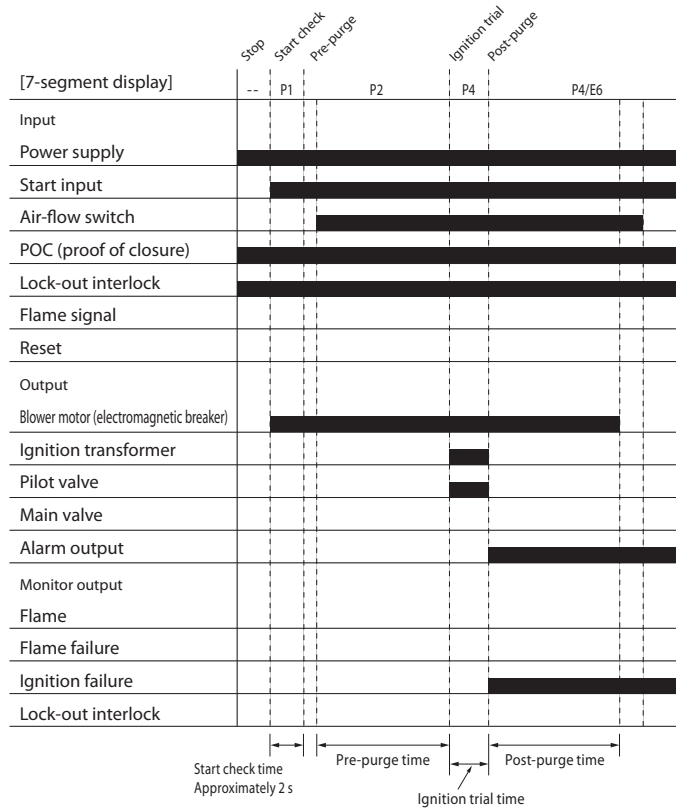

Input	Action	Sequence codes
Start input ON	When the start input is turned ON, the internal circuits are checked, and also checks are done to make sure that lock-out interlock is ON (normal), that the shutoff valve proof of closure switch is ON (POC function enabled), and that the air-flow switch is OFF. K10 is turned ON and the blower motor is turned ON.	P1
	The air-flow switch remains ON with the pre-purge timing.	P2
	After the pre-purge timing is completed, K3 and K5 are turned ON to perform the output of the ignition transformer and pilot valve.	P4
	If flame is not detected before the ignition trail time elapses, K5 is turned OFF, K6 is turned ON, and lock-out occurs. With regards to monitor output, ignition failure output is generated. In that case, K10 remains ON and the blower motor continues to operate until post-purge is complete. After the post-purge time elapses, K10 is turned OFF and the blower motor is turned OFF. During post-purge (at tie time of alarm), reset operation is not accepted.	P4/E6

● No ignition  
 • Direct ignition type

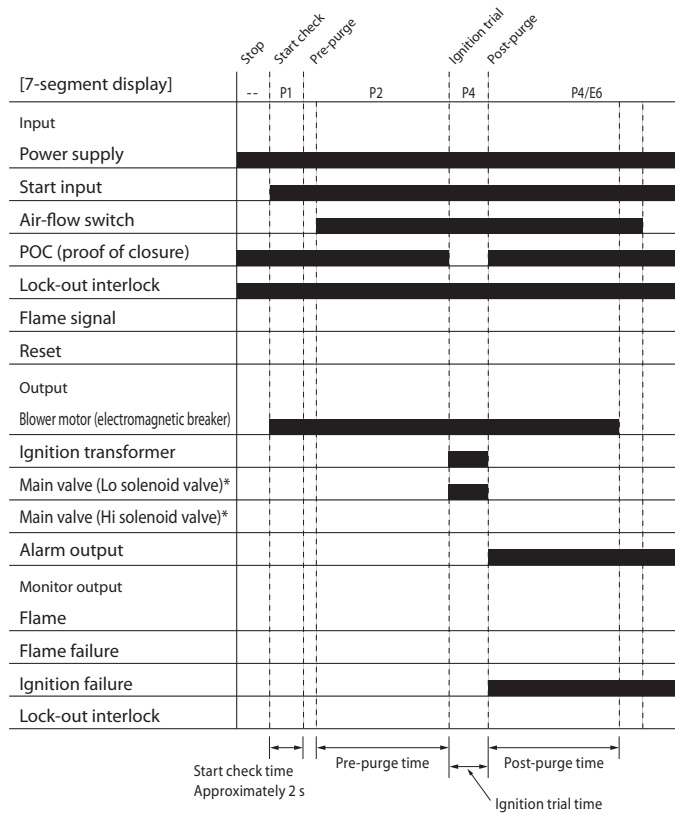

\* Content in ( ) describes the situation when three-position (Off-Lo-Hi) control is used.  
 If other than three-position control is used, only look at the main valve (Lo solenoid valve)

Input	Action	Sequence codes
Start input ON	When the start input is turned ON, the internal circuits are checked, and also checks are done to make sure that lock-out interlock is ON (normal), that the shutoff valve proof of closure switch is ON (POC function enabled), and that the air-flow switch is OFF. K10 is turned ON and the blower motor is turned ON.	P1
	The air-flow switch remains ON with the pre-purge timing.	P2
	After the pre-purge timing is completed, K3 and K5 are turned ON to perform the output of the ignition transformer and main valve (Lo solenoid valve). Within 3 seconds after the main valve is turned ON, check to make sure that the shutoff valve closure check switch is OFF (POC function enabled).	P4
	If flame is not detected at the completion of the ignition trail time, K6 is turned ON and a lock-out occurs. Monitor output performs the output of an ignition failure. In that case, K10 remains turned ON and the blower motor continues the operation until post-purge is completed. After the post-purge timing is completed, K10 is turned OFF and the blower motor is turned OFF. During post-purge (at the time of alarm), reset operation is not accepted.	P4/E6

● **Flame failure**  
 • Interrupted pilot type

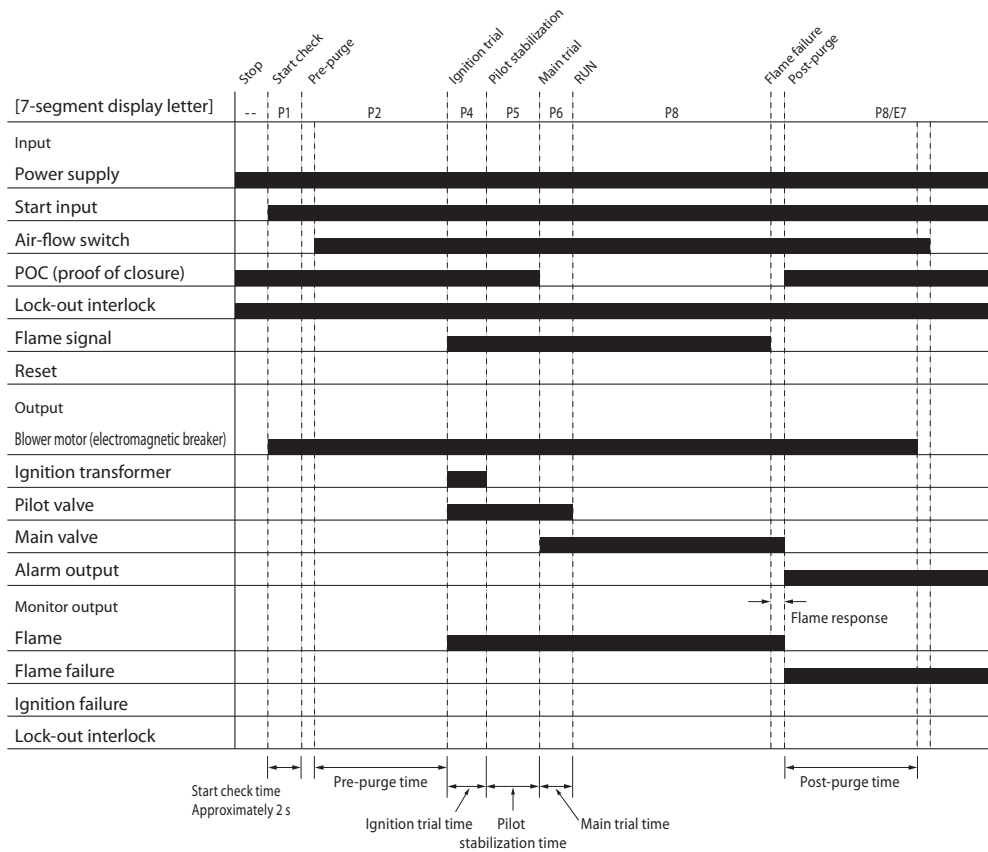

Input	Action	Sequence codes
Start input ON	The start input is turned ON, a start check and ignition operation are performed, and then RUN sequence is performed.	<i>P8</i>
	If the flame is extinguished during RUN sequence for some reason, the loss of flame is detected after the flame failure response time, and then K1, K2, and K4 are turned OFF, the main valve output is turned OFF, K6 is turned ON, and lock-out occurs. With regard to monitor output, flame failure output is generated. In that case, K10 remains ON and the blower motor continues to operate until post-purge is complete. After the post-purge time has elapsed, K10 is turned OFF and the blower motor is turned OFF. During post-purge (at the time of alarm), reset operation is not accepted.	<i>P8/E7</i>

● Flame failure  
 • Direct ignition type

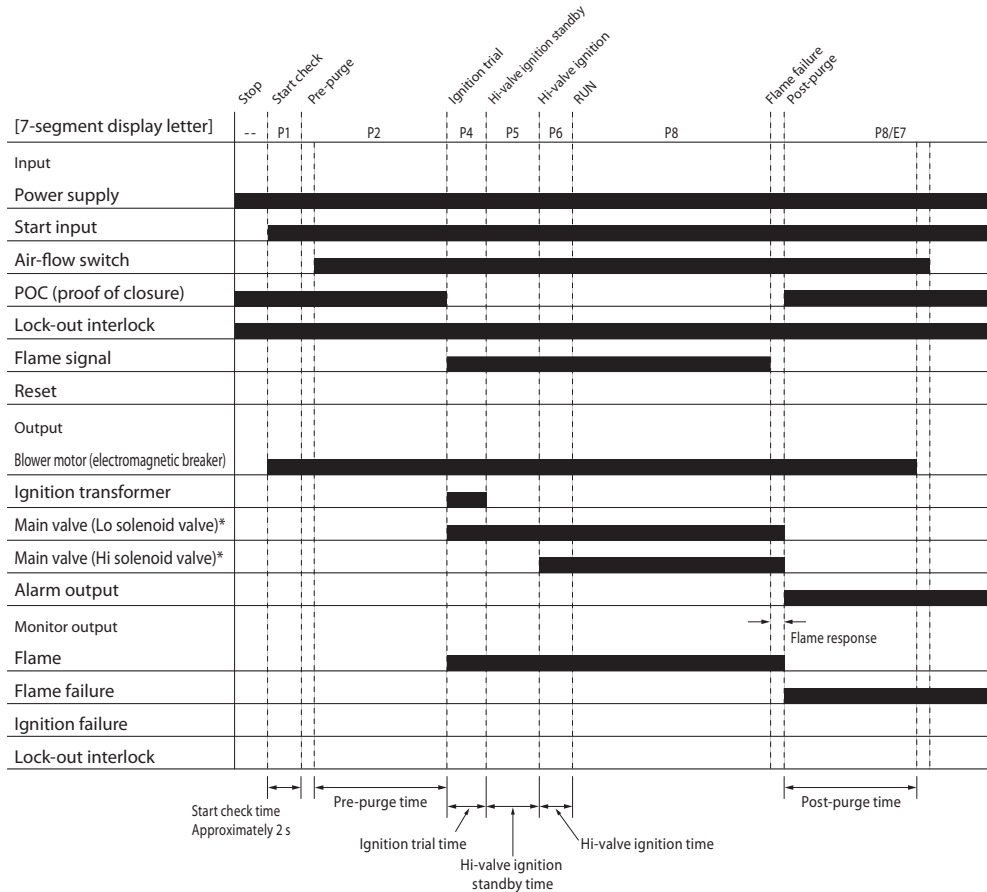

\* Content in ( ) describes the situation when three-position (Off-Lo-Hi) control is used.  
 If other than three-position control is used, only look at the main valve (Lo solenoid valve)

Input	Action	Sequence codes
Start input ON	The start input is turned ON, a start check and ignition operation are performed, and then RUN sequence is performed.	P8
	If the flame is extinguished during RUN sequence for some reason, the loss of flame is detected after the flame failure response time, and then K1, K2, and K4 are turned OFF, the main valve output is turned OFF, K6 is turned ON, and lock-out occurs. With regard to monitor output, flame failure output is generated. In that case, K10 remains ON and the blower motor continues to operate until post-purge is complete. After the post-purge time has elapsed, K10 is turned OFF and the blower motor is turned OFF. During post-purge (at the time of alarm), reset operation is not accepted.	P8/E7

● Start input during post-purge

• Interrupted pilot type

Transition to pre-purge without checking that the air-flow switch is Off or stopping the blower.

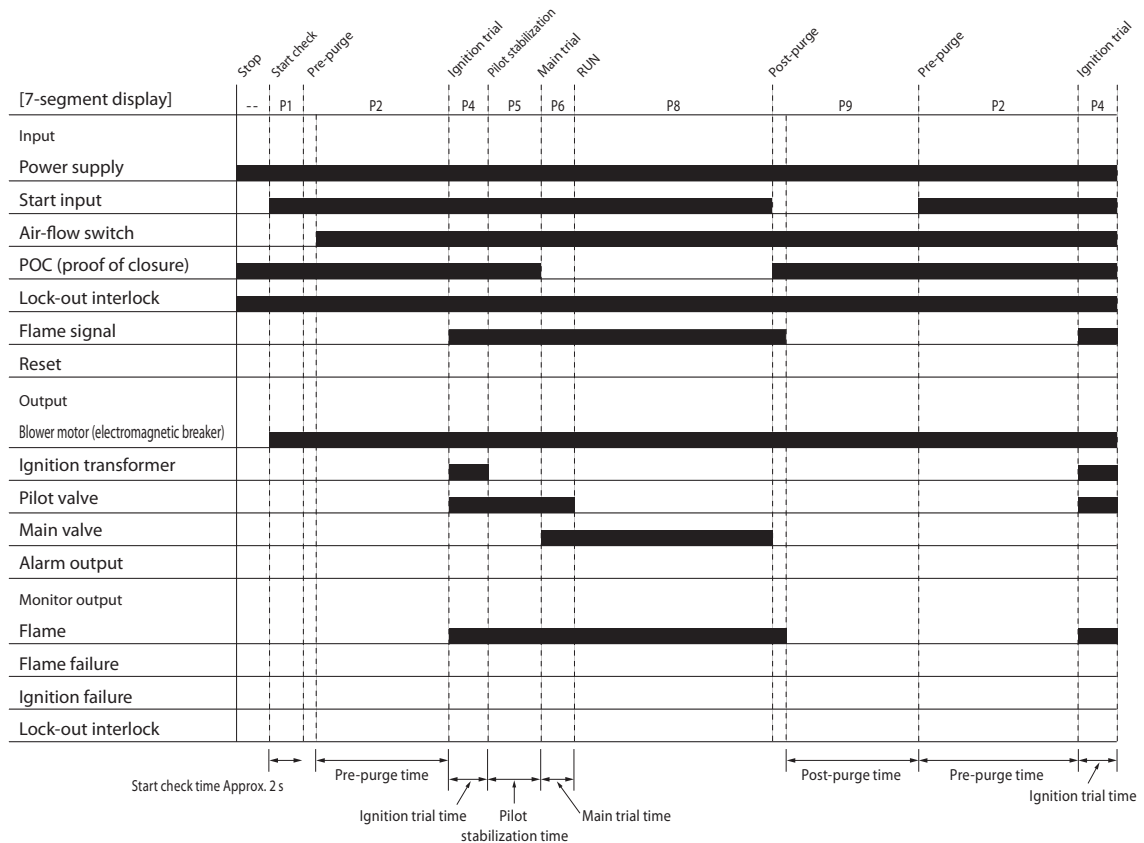

Input	Action	Sequence codes
Start input ON	The start input is turned ON, a start check and ignition operation are performed, and then RUN sequence is performed.	P8
Start input OFF	When the start input is turned OFF, K1, K2 and K4 are turned OFF and the main valve is turned OFF. K10 remains turned ON to keep the blower ON.	P9
Start input ON	If the start input is turned ON during post-purge, K10 remains ON. The air-flow switch remains ON with the pre-purge timing. (Transition to the purge sequence occurs without checking that the air-flow switch is OFF and without stopping the blower motor.)	P2

● Start input during post-purge  
 • Direct ignition type

Transition to pre-purge without checking that the air-flow switch is Off or stopping the blower.

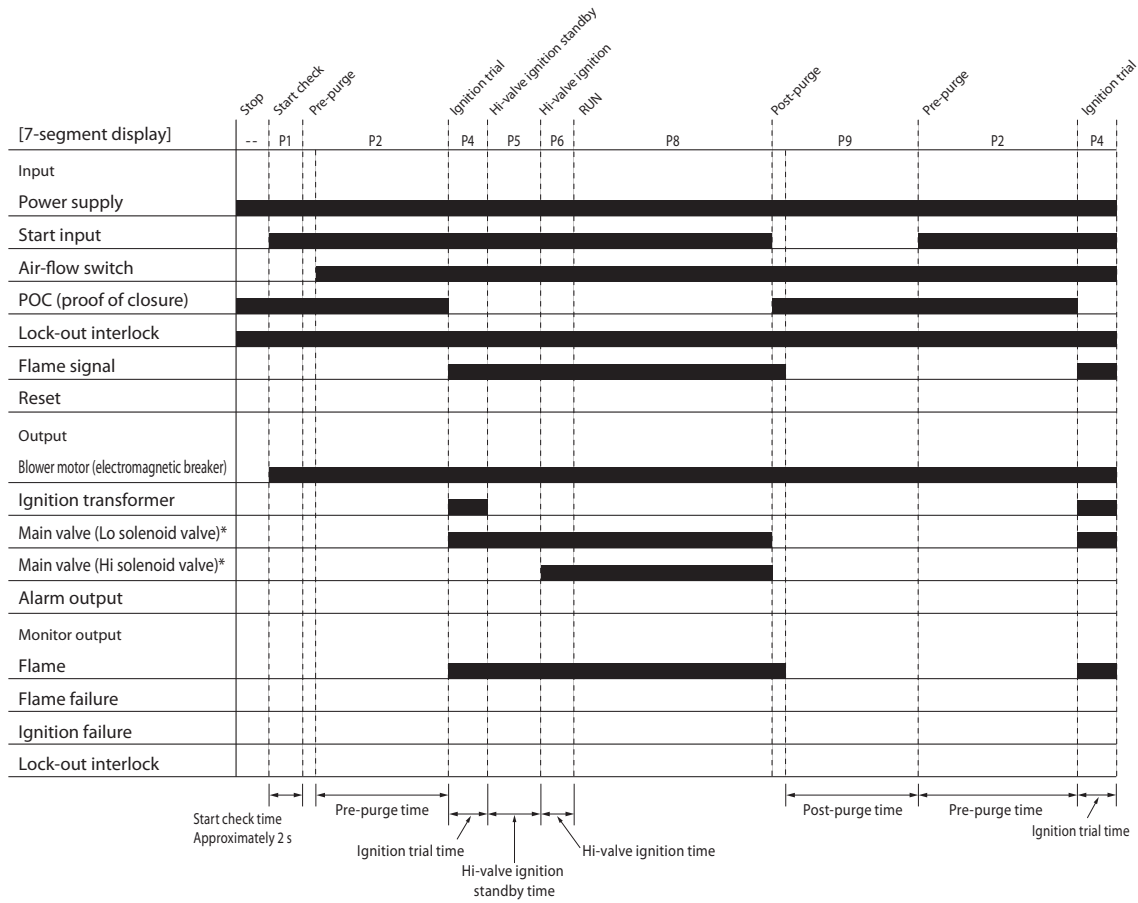

\* Content in ( ) describes the situation when three-position (Off-Lo-Hi) control is used.  
 If other than three-position control is used, only look at the main valve (Lo solenoid valve)

Input	Action	Sequence codes
Start input ON	The start input is turned ON, a start check and ignition operation are performed, and then RUN sequence is performed.	P8
Start input OFF	When the start input is turned OFF, K1, K2 and K4 are turned OFF and the main valve is turned OFF. K10 remains turned ON to keep the blower ON.	P9
Start input ON	If the start input is turned ON during post-purge, K10 remains ON. The air-flow switch remains ON with the pre-purge timing. (Transition to the purge sequence occurs without checking that the air-flow switch is OFF and without stopping the blower.)	P2

● Interlock error  
 • Interrupted pilot type

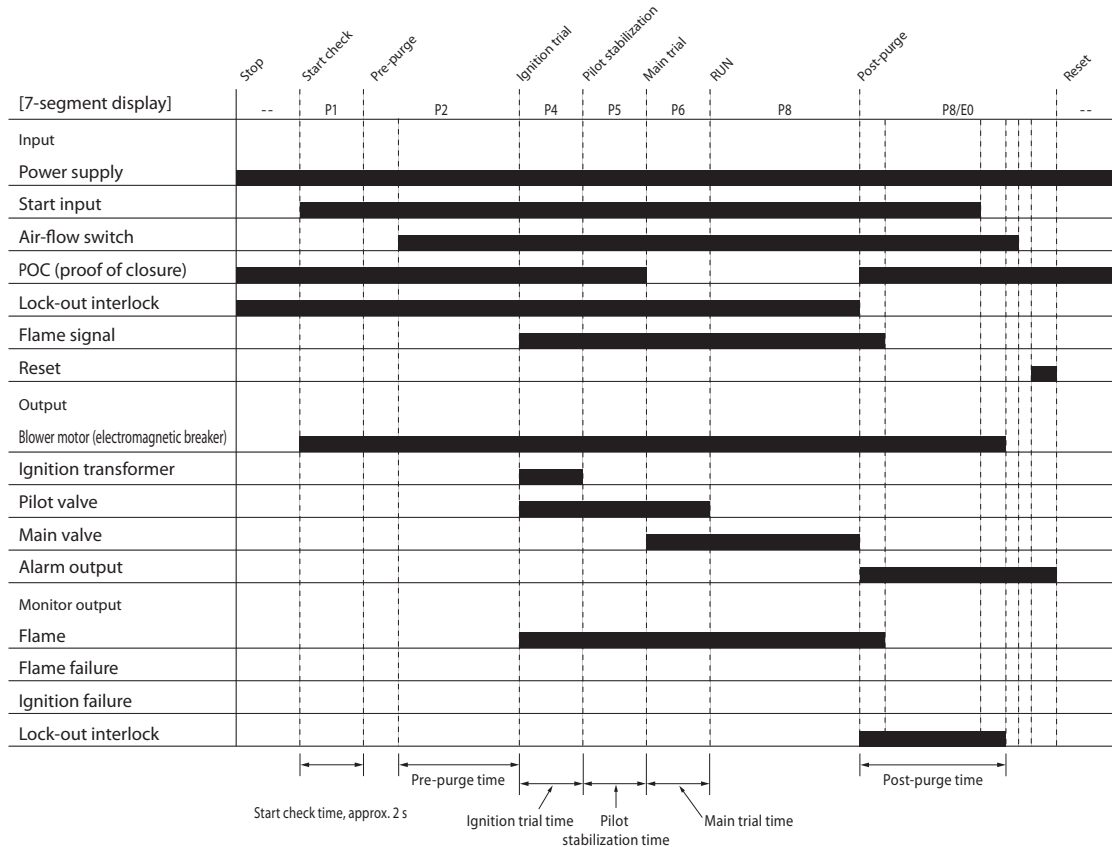

Input	Action	Sequence codes
Start input ON	The start input is turned ON, a start check and ignition operation are performed, and then RUN sequence is performed.	<i>P8</i>
Lock-out interlock OFF	If the lock-out interlock is turned OFF during RUN sequence, K1, K2, and K4 are turned OFF, main valve output is turned OFF, K6 is turned ON, and lock-out occurs. With regard to monitor output, lock-out interlock output is generated. In that case, K10 remains ON and the blower motor continues to operate until post-purge is complete. After the post-purge time has elapsed, K10 is turned OFF and the blower motor is turned OFF. During post-purge (at the time of alarm), reset operation is not accepted.  (The above sequence chart shows an example of turning off the start input during post-purge.)	<i>P8/E0</i>
Contact reset or device reset switch: ON	After the post-purge time has elapsed, if the reset switch is pressed and held for approximately 1 second, the lock-out state is cleared and K6 is turned OFF.	-

● Interlock error  
 • Direct ignition type

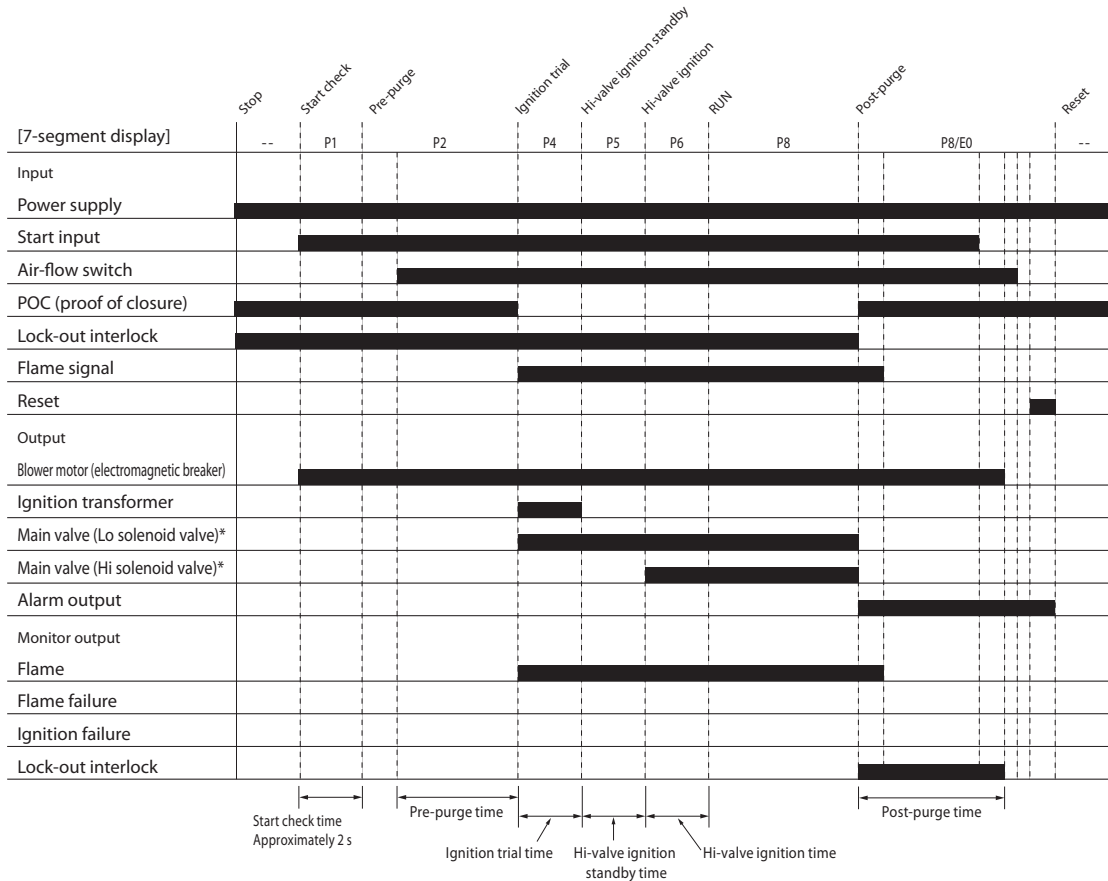

\* Content in ( ) describes the situation when three-position (Off-Lo-Hi) control is used. If other than three-position control is used, only look at the main valve (Lo solenoid valve)

Input	Action	Sequence codes
Start input ON	The start input is turned ON, a start check and ignition operation are performed, and then RUN sequence is performed.	P8
Lock-out interlock OFF	If the lock-out interlock is turned OFF during normal combustion, K1, K2, and K4 are turned OFF, main valve output is turned OFF, K6 is turned ON, and lock-out occurs. With regard to monitor output, lock-out interlock output is generated. In that case, K10 remains ON and the blower motor continues to operate until post-purge is complete. After the post-purge time has elapsed, K10 is turned OFF and the blower motor is turned OFF. During post-purge (at the time of alarm), reset operation is not accepted.  (The above sequence chart shows an example of turning off the start input during post-purge.)	P8/E0
Contact reset or device reset switch: ON	After the post-purge time has elapsed, if the reset switch is pressed and held for approximately 1 second, the lock-out state is cleared and K6 is turned OFF.	-



● False flame occurred during pre-purge (interrupted pilot type / direct ignition type)

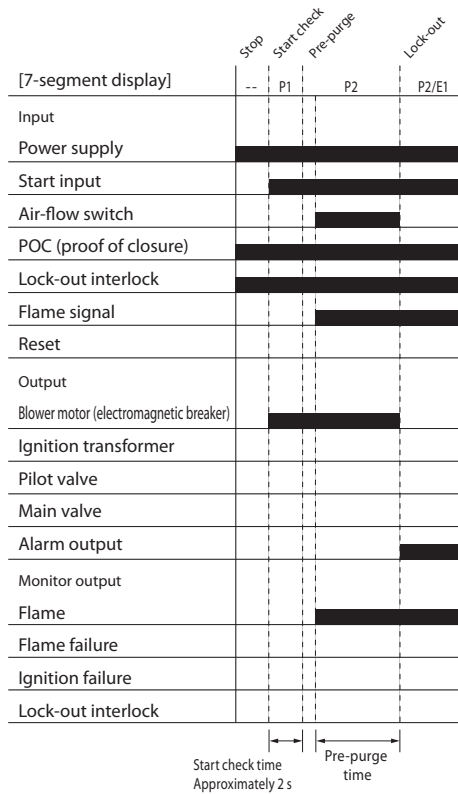

Input	Action	Sequence codes
Start input ON	When the start input is turned ON, the internal circuits are checked, and also checks are done to make sure that lock-out interlock is ON (normal), that the shutoff valve proof of closure switch is ON (POC function enabled), and that the air-flow switch is OFF.	P1
	The air-flow switch ON check is performed.	P2
	A false flame is detected during the pre-purge sequence. After the false flame state continues for 5 seconds, K6 is turned ON and lock-out occurs.	P2/E1

● False flame occurred before the start input. Then, the start input was turned ON (interrupted pilot type/direct ignition type)

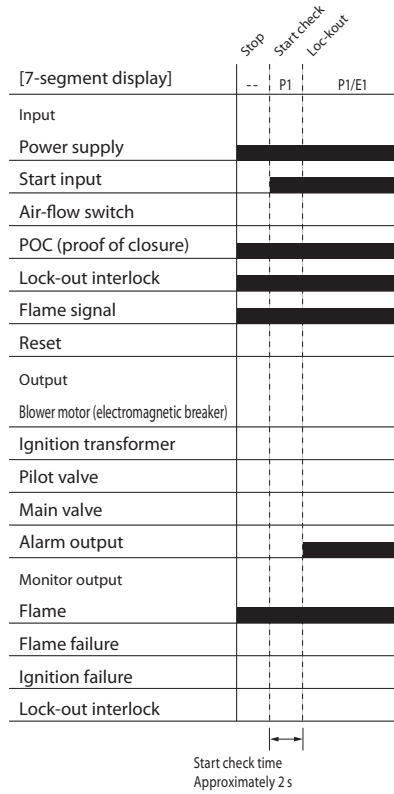

Input	Action	Sequence codes
After the power is turned ON, a false flame is detected.	During the stop sequence, a false flame is detected.	-
Start input ON	After the start input is turned ON, the false flame is monitored. The start check part of the sequence continues.	P1
	After the false flame state continues for 5 seconds, K6 is turned ON and lock-out occurs.	P1/E1

● The air-flow switch was not turned ON during pre-purge (interrupted pilot type/direct ignition type)

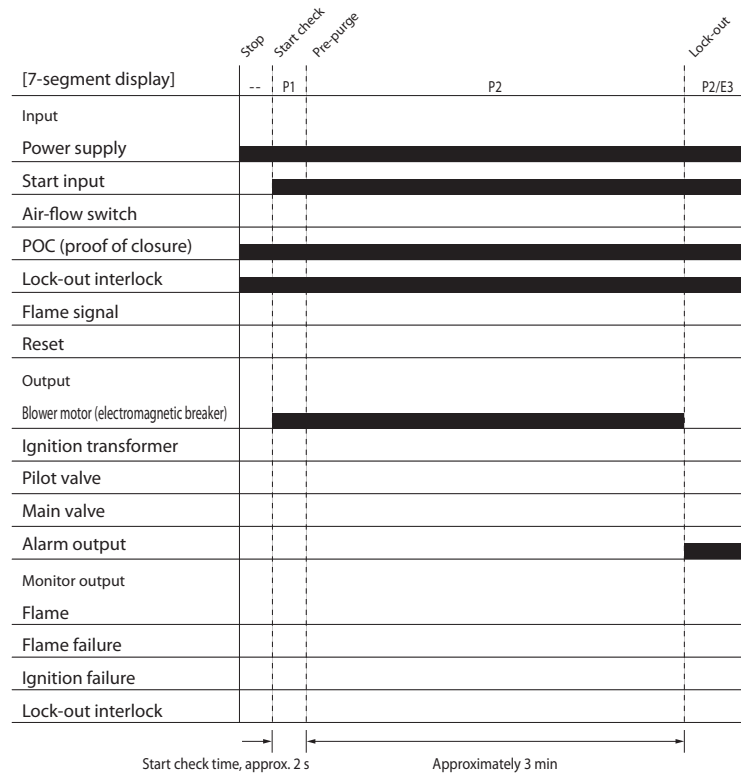

Input	Action	Sequence codes
Start input ON	When the start input is turned ON, the internal circuits are checked, and also checks are done to make sure that lock-out interlock is ON (normal), that the shutoff valve proof of closure switch is ON (POC function enabled), and that the air-flow switch is OFF.	P1
	The air-flow switch ON check is performed.	P2
	If the air-flow switch is not turned ON within 3 minutes, K6 is turned ON and lock-out occurs. At the same time that lock-out occurs, K10 is turned OFF and the blower motor is turned OFF.	P2/E3

● Lock-out interlock Off (open) at start input (interrupted pilot type/direct ignition type)

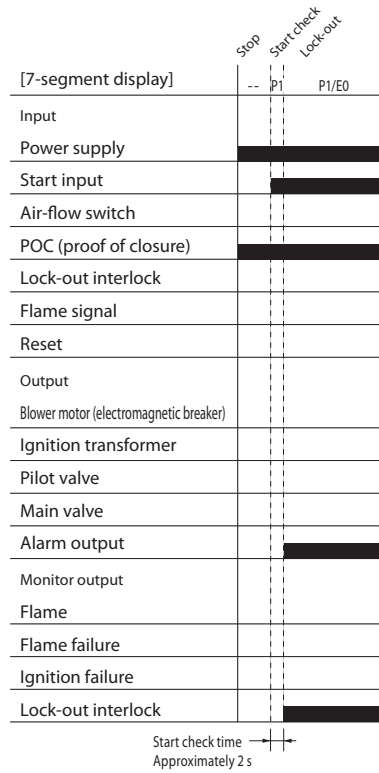

Input	Action	Sequence codes
Start input ON	Check the internal circuit when the start input is turned ON, and also check to make sure that lock-out interlock is ON (normal), the shutoff valve closure check switch is ON (POC function enabled) and the air-flow switch is OFF.	<i>P1</i>
	If lock-out interlock ON (normal) cannot be confirmed, K6 is turned ON and lock-out occurs. Monitor output lock-out interlock is turned ON.	<i>P1/E0</i>

### ■ Alarm and occurrence sequence

Name	Symbol	Interlock Error	False flame	Air-flow switch error (1)	Air-flow switch error (2)	Ignition failure	Flame failure	POC (proof of closure) error
		<i>E0</i>	<i>E1</i>	<i>E2</i>	<i>E3/EA</i>	<i>E6</i>	<i>E7</i>	<i>E8</i>
Stop	--							
Start check	<i>P1</i>	○	○		○			○
Pre-purge	<i>P2</i>	○	○		○			○
Ignition trial	<i>P4</i>	○		○		○		○
Pilot stabilization / Hi-valve ignition standby	<i>P5</i>	○		○			○	○
Main trial / Hi-valve ignition	<i>P6</i>	○		○			○	○
RUN	<i>P8</i>	○		○			○	○
Post-purge	<i>P9</i>							





Explanation of symbols in the table

Blank: Not monitored



○ : Monitored

# Chapter 5. Trial Operation and Adjustment

## **WARNING**

-  Make sure that the ignition times for the pilot and main burners do not exceed the ignition times specified by the burner or device manufacturer. Excessive ignition times may cause fuel to accumulate in the combustion chamber and form an explosive fuel-air mixture, which can result in a serious explosion hazard.
-  Terminal 14 (F) retains an electrical charge even after the power is turned off. Do not touch terminal F even after turning the power off. Failure to do so may result in an electric shock.
-  Do not operate this device without first completing calibration, testing, and combustion equipment manufacturer's tests.
-  If lock-out occurs, make sure to execute a pre-purge before restarting. If unburned gas is not expelled from the combustion chamber and flue, there is a risk of an explosion during ignition.

## **CAUTION**

-  Mounting, wiring, maintenance, inspection, calibration, etc. should be carried out by a professional with technical training in combustion systems and combustion safety devices.
-  The pilot turn-down test should be carried out by an experienced specialist possessing knowledge and skills pertaining to combustion equipment and combustion safety.

### ■ Preliminary inspection

- (1) The temperature and humidity are within the ranges specified for operating conditions.
- (2) There are no errors in wiring and terminal screws are not loose.
- (3) The flame detector is installed correctly. (For the installation location, orientation, and other details, see the user's manual for the flame detector.)
- (4) The burner is adjusted correctly.
- (5) There are no obstructions, covers, or other items in the combustion air intake or exhaust outlet.
- (6) The power supply voltage and frequency are the same as those shown on the device.

### ■ Inspection procedure

For safe operation of the combustion equipment, inspect the following items carefully and make appropriate adjustments.

■ Ignition spark response (UV sensor)

 **WARNING**



Ensure that the UV sensor does not detect ultraviolet rays other than those from the burner. If the UV sensor responds to other ultraviolet radiation, fuel will continue to be supplied even if the burner flame is off, potentially causing an explosion.



Before doing the spark response test, always make sure that all manual fuel valves are closed.

- (1) Close the manual valves in the piping for the pilot and main burners.
- (2) Begin operation and measure the flame voltage during the ignition trail sequence to check for any effect from the ignition spark.
- (3) If the spark has an effect, such as causing the FLAME LED to light up, refer to the user's manual for the equipment and make adjustments in the following way.
  - Move the UV sensor or the ignition spark rod so that the spark does not affect the flame voltage.
  - Attach a shield that prevents the spark's ultraviolet radiation from entering the optical path of the UV sensor. Adjust so that the spark's effect on the flame signal is 0.4 Vdc or less.
  - In the case of a solid-state power semi-terminal drive igniter (S720AxxxGHx or S720AxxxGHx), swap the polarity of the power to the igniter. When this device is used in combination with a half-wave drive igniter, changing the polarity of the power can prevent the the UV sensor's detection of the spark.

 **Handling Precautions**

- Ensure that the UV sensor does not detect ultraviolet rays other than those from the burner flame.

Sources of ultraviolet radiation (other than the burner flame) that can activate the UV sensor include the following.

Examples:

Ultraviolet ray sources	1371 °C or hotter red-hot furnace wall (within 50 cm from wall)
	Ignition transformer, welding arc spark
	Gas laser
	Sun lamp
	Germicidal lamp, ultraviolet lamp, fluorescent lamp
	Strong flashlight (towards UV phototube)
Gamma ray and X-ray sources	X-ray analyzer, gamma ray analyzer/measurer
	Electron microscope
	X-ray machine
	High-voltage vacuum switch
	High-voltage capacitor
	Radioactive isotope
	Any other ultraviolet, gamma, or X-ray source

### ■ Measurement of flame voltage

This device shows the flame voltage on the 7-segment display. It can be checked by changing the display using the DISP switch on the front of the device.

Checking the flame voltage is the best way to determine whether or not the location of the flame detector is appropriate.

It should be checked during installation and servicing.

Checking it once per month or more can prevent shutdowns due to insufficient flame voltage.

Start the device and measure the voltage under various conditions, such as at startup and during normal operation.

Check to make sure that the flame voltage remains stable at 2.0 Vdc or more. The recommended flame voltage is 2.0 Vdc or more and it must be stable.

\* If this stable voltage cannot be achieved, the problem may be caused by one or more of the following. In such a case, do a thorough inspection.

- (1) The power supply voltage or frequency is not correct.
- (2) The air supply pressure or air-fuel ratio is not correct.
- (3) The flame detector is not correctly wired.
  - Open circuit
  - Short circuit
  - High-resistance short circuit of the lead wires due to the temperature or dirt
- (4) Incorrect flame monitoring direction (BC-R25C)
- (5) Dirty flame sensor surface (BC-R25C).
- (6) AUD15C tube unit deterioration (BC-R25C).
- (7) Incorrect flame rod installation (BC-R25B).
  - Area in contact with flame is insufficient.
  - Position of flame rod in flame is incorrect.
  - The flame rod insulator is at a high temperature (315 °C).
  - Flame rod is affected by ignition transformer.

If the ignition transformer is placed close to Terminal F of the flame rod, electrons in the flame are absorbed into the ignition transformer, and as a result, sufficient flame voltage cannot be achieved.

#### (Ref.) Correlation of flame output with that of older model

• BC-R25C (AUD100/110/120)

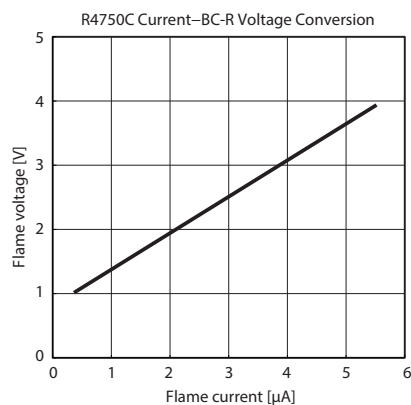

• BC-R25B (flame rod)

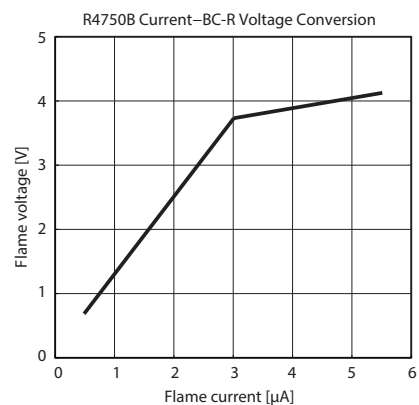



### ● Measurement method for flame voltage

The voltage can be checked on the 7-segment display or by connecting a flame meter to terminals 25 and 26 of the front connector.

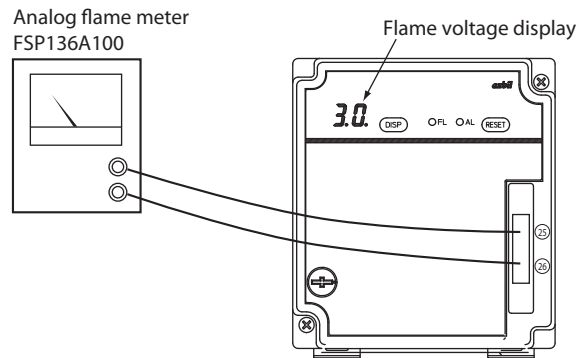





\* Connector for front wiring (81447514-001/002) is required to connect FSP136A100 to BC-R25 series.

### ! Handling Precautions

- For flame voltage output signal wires, use wire with indoor PVC insulation ("IV wire," JIS C3307) 0.75 mm<sup>2</sup>. Wiring length cannot be more than 10 m.
- The input impedance of a measuring instrument used with this device must be 100 kΩ or more.

## ■ Pilot turn-down test

### **WARNING**

-  Make sure that the pilot turn-down test is done properly. If the flame detector is able to detect a pilot flame that is too small to ignite the main burner, and if there is a flame failure of the main burner, this device will not be able to recognize the flame failure. As a result, fuel will continue to be supplied, resulting in an explosion hazard.
-  Before doing the pilot turn-down test, always make sure that all manual fuel valves are closed.
-  If the pilot turn-down test must be repeated, stop the combustion equipment completely each time and discharge all of the unburned gas and oil from the fuel chamber and flue. Failure to discharge unburned gas may result in an explosion hazard.
-  After completing the pilot turn-down test, turn off the power switch to turn off the power supply. Make sure to return all test jumpers and limit or controller settings to their original values. Resuming normal operation without returning the settings to their original values, etc., may damage the equipment or cause a gas leak or explosion.

### **CAUTION**

-  The pilot turn-down test should be carried out by an experienced specialist possessing knowledge and skills pertaining to combustion equipment and combustion safety.

The purpose of this test is to determine the smallest possible pilot flame that will reliably ignite the main burner.

Before and after this test, make sure to measure the flame voltage and confirm that it is 2.0 V or more. This device has a trial operation mode. If pilot turn-down is selected in the trial operation mode, the device does not proceed to RUN sequence, but instead continues with pilot combustion. When the trial operation mode is used, the pilot turn-down test can be executed by turning on and off the start input. For instructions on starting trial operation mode, see chapter 3.

- (1) Turn off the power switch and stop all the equipment.
- (2) Close the main valve (by removing one side of the wiring to the main valve or by closing the manual cock) to cut off the gas to the main burner. The pilot valve remains in its normal state.
- (3) Turn on the power switch. If the start input is on, the ignition sequence begins after the pre-purge, as soon as the pilot valve is opened.
- (4) After the pilot burner ignites, turn the pilot valve (manual cock) down until the burner controller extinguishes the flame. Mark the position of the manual cock at the time when the flame is extinguished. Then, press the reset switch to reset the error and restart it. Turn the manual cock back until just before the previously marked position (so that more gas is output).

#### ● **Key Point**

When the trial operation mode is used, the pilot burner combustion continues and there is no limitation on the ignition trial time. Therefore, it is easy to check.

- (5) Turn off the power switch, return the main valve to the normal state and then turn on the power switch again. After the pre-purge, pilot burner combustion begins and then main burner combustion begins.

If the main burner does not ignite, turn off the power switch immediately.

The pilot flame is too small, so it must be increased. In that case, correct the installation location of the flame detector so that the monitoring angle of the flame detector is slightly away from the pilot flame monitoring axis.

### Handling Precautions

- If it is necessary to repeat the test, each time it is repeated be sure to stop all the equipment first to prevent an explosion and then discharge all unburned gas that has accumulated in the combustion chamber and exhaust flue.
  - Also when executing the pilot turn-down test using the trial operation mode, where there is a risk because the main valve is on, force the gas to be cut off by using the manual cock or disconnecting the wiring.
- (6) Change the gas pressure from the minimum to the maximum and repeat steps (1) to (5) to check if the main burner ignites properly.

### ■ Safety shutoff check

#### (1) Interlock check

While the burner is operating, simulate the operation of each interlock and check if lock-out or shutdown occurs.

After checking, return the settings to their original values and restart the burner to check that it ignites normally.

#### (2) Ignition trail failure check

Close the manual gas cock. Turn on the start input of the burner to begin operation. After the pre-purge, an attempt is made to ignite the pilot burner. Since the manual cock is closed, however, the pilot burner does not ignite and lock-out occurs.

After confirming the above behavior, open the manual cock. Turn on the reset switch, restart the burner and check if it ignites normally.

#### (3) Flame failure check

Close the manual gas cock while the burner is operating. After the flame failure response time elapses, the pilot valve and main valve close and lock-out occurs. After confirming the above behavior, open the manual cock. Turn on the reset switch, restart the burner and check if it ignites normally.

#### (4) Power loss (power failure) check

Turn off the power switch during burner operation in order to stop combustion. After waiting for a while, turn on the power switch again.

Then, turn on the start input, restart the burner and check if it ignites normally.

# Chapter 6. Maintenance and Inspection

## **WARNING**



Ensure you turn off the power of this device and all auxiliary devices when mounting, removing or connecting the wires of this device. There is a risk of electrical shock.



Terminal 14 (F) retains an electrical charge even after the power is turned off. Do not touch terminal 14 (F) even after turning the power off. Doing so may result in an electric shock.

## **CAUTION**



Mounting, wiring, maintenance, inspection, calibration, etc. should be carried out by a professional with technical training in combustion systems and combustion safety devices.



If the device undergoes safety shutdown and restarts, do all of the inspection steps described in chapter 5, "Trial Operation and Adjustment."



As part of the maintenance and inspection of the burner, make sure to do the pilot turn-down test. Inspect the burner at least once a year.



Also, follow the instructions for periodic inspection that are given in the combustion equipment manufacturer's manual.



When cleaning the burner, clean the flame detector also.

### ■ General maintenance and inspection

- When replacing this device, do all of the checks and adjustments, including those mentioned in the notices on page 1.
- Do not lubricate any part of this device.
- Remove any products of combustion that are stuck to the burner or other equipment.

### ■ Maintenance and inspection cycle

The maintenance and inspection cycle should take into consideration the device type, ambient conditions of the installation location, the frequency of use, etc. The following are approximate guidelines.

- Cleaning the burner: once or more per year  
After cleaning, make sure to do the pilot turn-down test.
- Burner shutdown check: once or more per month
- Flame voltage check: once or more per month

## ■ Alarm codes and details

When lock-out occurs, an alarm code is displayed automatically. When an alarm occurs, the sequence number and alarm code issued when the lock-out occurred are displayed alternately. Refer to chapter 4, "Relationship between Error Occurrence and Sequence."

Alarm code	Sub-code	Description	Status
E0	None	Interlock error	Lock-out interlock operated
E1		False flame	The flame signal is detected for 5 s during pre-purge
E2		Air-flow switch error (1)	The air-flow switch turned off during combustion.
E3		Air-flow switch error [2]	The air-flow switch stayed on for 3 minutes during the start check.
		Air-flow switch error [2]	The air-flow switch stayed off for 3 minutes during pre-purge.
E6		Ignition failure	At the end of P4 (pilot ignition or main ignition), flame could not be detected.
E7		Flame failure	In the sequence following P4 (pilot ignition or main ignition), the flame signal disappeared.
E8		POC (proof of closure) error	POC (proof of closure) switch was detected to be off (open) when the main valve was closed. POC (proof of closure) switch was detected to be on (closed) when the main valve was open. Note: To disable POC, see " <b>Function selection mode</b> " in chapter 3, "Operation."
E9	02	Switch input error	The DISP switch, RESET switch or reset input stayed on for 60 seconds. Note: Monitoring is continuous while power is supplied.
E9	03	Internal relay feedback (K1)	Relay K1 failure (contact welding) Note: If this error recurs even after a manual reset, a device failure may have occurred.
E9	04	Terminal 4 and 5 voltage discrepancy (K2)	Voltage from terminal L2 (power supply) is applied to terminals 4 and 5. Note: Check that all combustion load output common lines connected to terminals 6, 7, and 8 are wired to terminals 4 and 5.
E9	05	Terminal 7 voltage discrepancy (PV)	At terminal 7, while pilot valve or main valve output was OFF, voltage was detected for 30 seconds. Note: This error can occur because of a ground fault, voltage supply to terminal 7 from an external circuit (bypass circuit, etc.), or relay K3 failure (contact welding, etc.).
E9	06	Terminal 8 voltage discrepancy (MV)	At terminal 8, while main valve output was OFF, voltage was detected for 30 seconds. Note: This error can occur because of a ground fault, voltage supply to terminal 8 from an external circuit (bypass circuit, etc.), or relay K4 failure (contact welding, etc.).
E9	07	Terminal 6 voltage discrepancy (IG)	At terminal 6, while the ignition transformer output was OFF, voltage was detected for 30 seconds. Note: This error can occur because of a ground fault, voltage supply to terminal 6 from an external circuit (bypass circuit, etc.), or relay K5 failure (contact welding, etc.).
E9	08	Alarm generation when power is turned ON	When the cause of lock-out cannot be identified • Power was turned off before CPU error judgment after lock-out occurred • Latch relay was set to lock-out due to vibration during transport or for other reasons
E9	50 to 71	Other problems	Device failure or malfunction due to external electrical noise * Check that there is no grounding failure, and that high-voltage cables and signal wires do not run together. If there is an inverter or the like that generates strong electrical noise near this device, take noise-suppression measures, referring to the user's manual for the noise-generating equipment. Note: If this error recurs even after a manual reset, a device failure may have occurred.

- If the sequence cannot be specified, the sequence code displayed when lockout occurred may be shown as [– –] (stopped).

■ Failure inspection flow



**WARNING**



Before removing, mounting, or wiring the module, be sure to turn OFF the power to the module and all connected devices. Failure to do so may result in an electric shock.

If there is any problem with the device, follow the inspection procedure below.

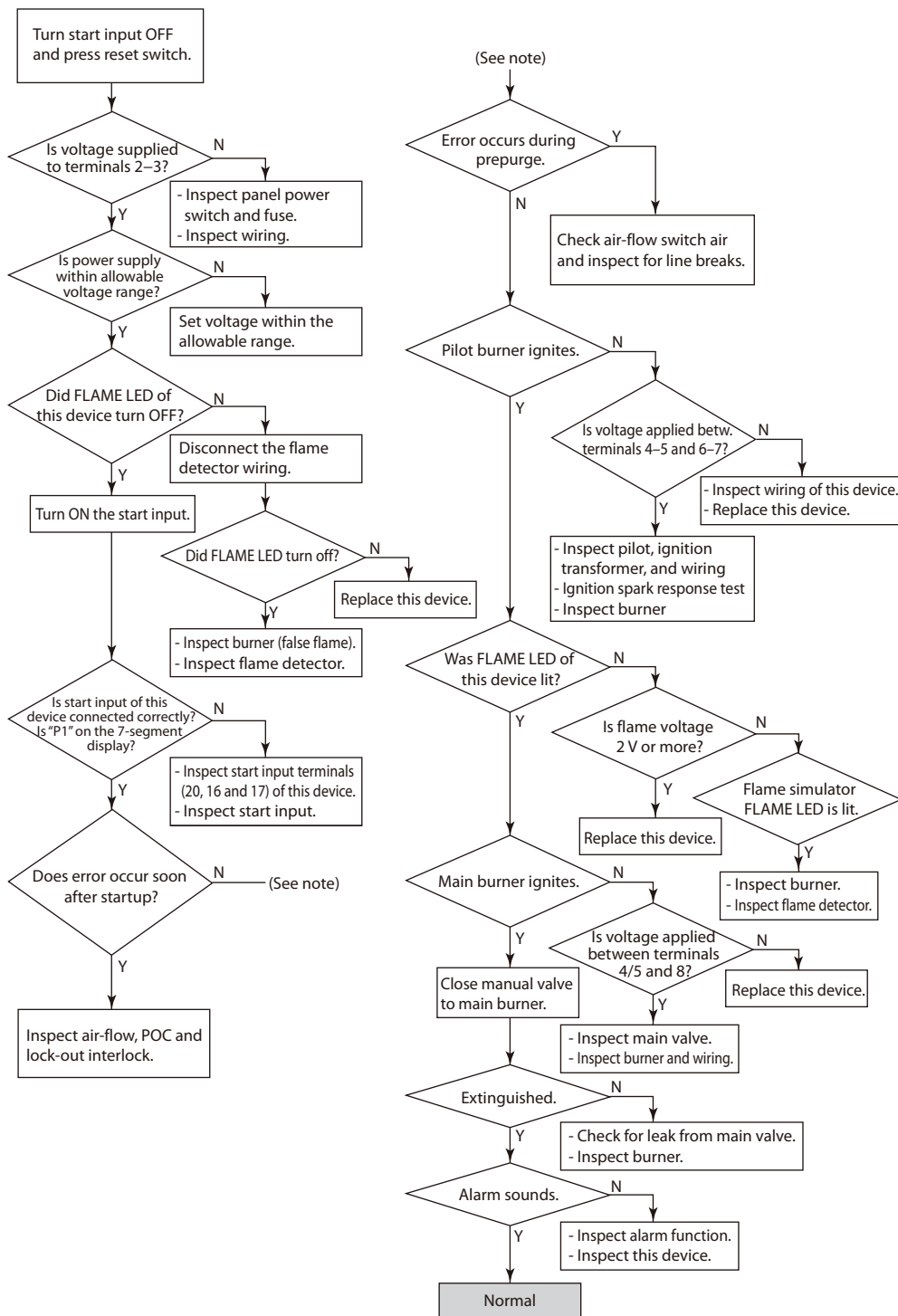

# Chapter 7. Specifications

Item		Description				
Application		Batch-operated combustion systems burning gas, oil, or gas/oil mixture				
Compatible flame detector		AUD100/110/120 series UV sensor, flame rod				
Sequence	Sequence timing	Pre-purge	Ignition trial	Pilot stabilization (Hi-valve ignition standby) *1	Main trial (Hi-valve ignition) *1	Post-purge
		35 s, 45 s, 60 s, 3 min (select by model number)	4.5±0.5 s	8.5±1 s	4.5±0.5 s	20±2 s
	Flame failure response timing	AUD100/110/120 series UV sensor			Flame rod (ionization)	
		2 s max (nominal 1.5 s) (when flame voltage is 3 V)			2 s max (nominal 1.5 s) (when flame voltage is 2V)	
	Reset timing	1 s or longer (reset switch or contact reset input)				
	Alarm detection timing	False flame	Air-flow switch (1)	Air-flow switch (2)	Interlock error	POC (proof of closure) error
		5 s	1 s max.	180 s	1 s max.	3 s
	Air-flow switch observation	Available (performs observation of air-flow switch malfunction (1), (2))				
	Operation at ignition failure	Lock-out				
	Operation at flame failure	Lock-out				
Electrical specifications	Rated power supply	100 Vac or 200 Vac (depending on the model), 50 Hz or 60 Hz				
	Allowable power supply voltage	85-110% of rated power supply				
	Power consumption	10 W or less				
	Dielectric strength	1500 Vac for 1 min, or 1800 Vac for 1 s Between each terminal and ground (the DIN rail clamp), except for combustion sensor connection terminals (terminals 14, 15)				
	Insulation resistance	50 MΩ min. with 500 Vdc megger Between each terminal and ground (the DIN rail clamp), except for combustion sensor connection terminals (terminals 14, 15)				
	Contact rating	Blower motor (electromagnetic switch)	Ignition transformer	Pilot valve (main valve Lo solenoid valve)*1	Main valve (main valve Hi solenoid valve) *1	Alarm
		100 VA	300 VA	200 VA	200 VA	75 VA
	Monitor outputs*2	4, maximum 30 mA each				
	Flame detection level	AUD100/110/120 series UV sensor			Flame rod (ionization)	
		Flame establishment: 1.5-4.5 Vdc Flame-out detection: 0.2-0.6 Vdc			Flame establishment: 1.5-4.5 Vdc Flame-out detection: 0.0-0.2 Vdc	
	Flame voltage output	Recommended flame voltage: Must be stable at 2 Vdc or above Flame voltage output range:0.2-4.5 Vdc			Recommended flame voltage: Must be stable at 2 Vdc or above Flame voltage output range: 0.0 - 4.5 Vdc	
	Input	Start, lock-out interlock, contact reset, air-flow switch, POC (proof of closure) Each input is a non-voltage contact input, with allowable contact resistance up to 500 Ω				
	Life	10 years when used for eight hours per day, or 100,000 start/stop cycles (at 25 °C, room humidity, rated voltage)				
Operating conditions	Ambient temperature	-20 to +60°C				
	Ambient humidity	10-90%RH (no condensation)				
	Vibration	0-3.2 m/s <sup>2</sup> (10-150 Hz, 1 octave/minute, 10 cycles, in each of XYZ directions)				
	Shock	0-9.8m/s <sup>2</sup>				
	Mounting angle	Reference plane +/-10°				
	Dust	0.3 mg/m <sup>3</sup> or less				

## Chapter 7. Specifications

General specifications	Protection rating	IP40 (with sideboards (81447515-001) attached to the sub-base (BC-R05)) IP10 (sub-base (BC-R05) only)
	Overvoltage category	II
	Pollution degree	PD2
	Case color	Black
	Case material	Denatured PPE resin (UL94-V0 PTI Material group IIIa)
	Structure	Sub-base and main device
	Mounted orientation	Vertical or horizontal However, for horizontal attachment, 7 segment display can only be mounted so that it faces directly overhead (DIN rail mounting or direct mounting through base screw holes)
	Standards	JIS C 9730-2-5:2010 (Automatic Electrical Controls For Household And Similar Use - Part 2-5: Particular Requirements For Automatic Electrical Burner Control Systems) Compliant with JIS C 9730-1:2010 (Automatic Electrical Controls For Household And Similar Use - Part 1: General Requirements)
	Dimensions	W95 × H105 × D110mm
Weight	Approximately 600 g (incl. sub-base)	
Wiring types and max. wiring length	<ul style="list-style-type: none"> <li>• Start, air-flow switch, lock-out interlock, POC (proof of closure) Copper IV wire with 600V vinyl insulation, 1.25 mm<sup>2</sup> Recommended condition: 20 m or less, maximum wiring length: 100m</li> <li>• Contact reset Copper IV wire with 600V vinyl insulation, 1.25 mm<sup>2</sup>, maximum wiring length: 10 m</li> <li>• AUD100 Series (F, G) Copper IV wire with 600V vinyl insulation, 1.25 mm<sup>2</sup>, maximum wiring length: 100m</li> <li>• Flame rod (F, G) RG-11U (JAN standard: US DoD compliant specification) Or equivalent 5C2V, 7C2V (JIS standard) Recommended condition: 20 m or less, maximum wiring length: 30 m</li> <li>• RS-485 communications (3-wire system) 0.2-1.5mm<sup>2</sup> Shielded twisted pair cable (recommended) Maximum wiring length: 500m</li> <li>• Flame voltage output signal circuit IV wire 0.75 mm<sup>2</sup> or larger, max. wiring length 10 m</li> </ul>	

\*1 Item in ( ) is for the case of direct ignition.

\*2 If an inductive load is used, connect a protection circuit such as an RC snubber to the load in parallel.



External dimensions

(Unit: mm)

● Body

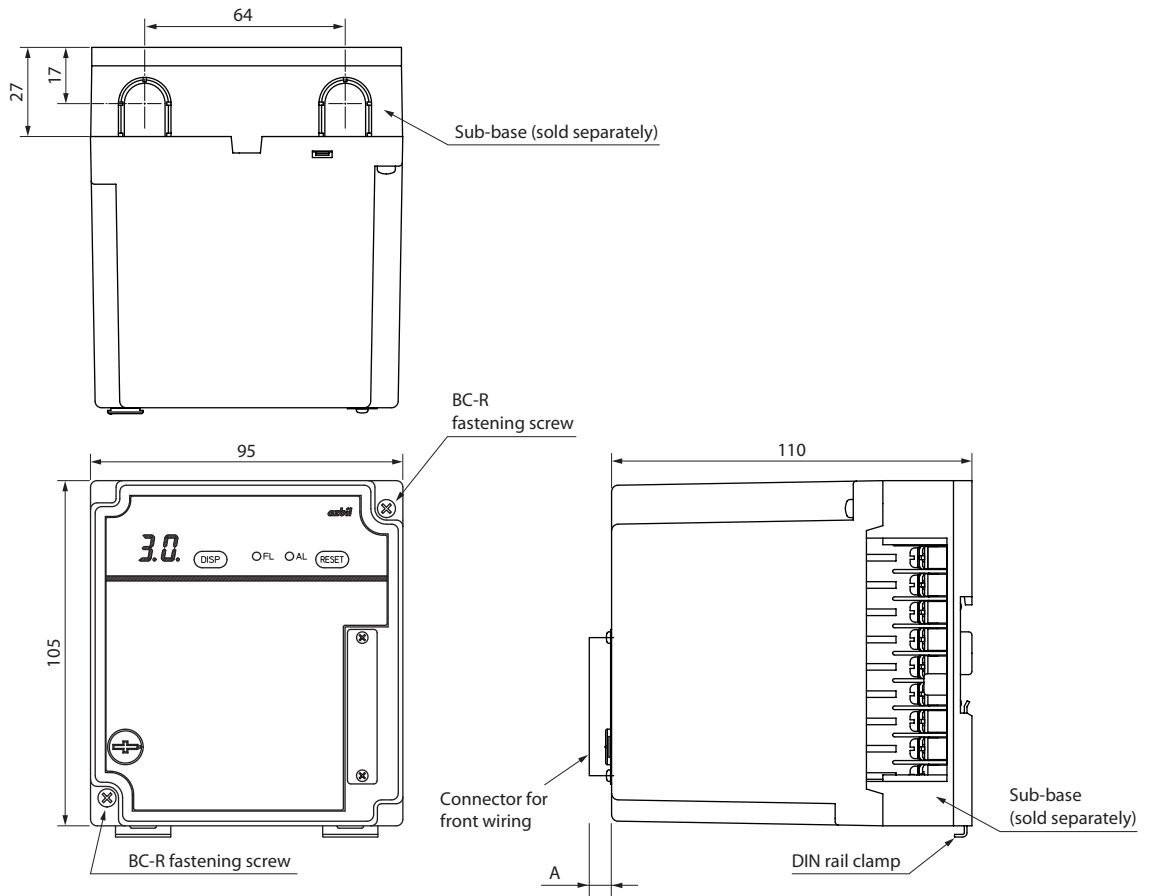

Model number	A
81447514-001	10.6
81447514-002	14.6

(Unit: mm)

● Sub-base BC-R05A100 (sold separately)

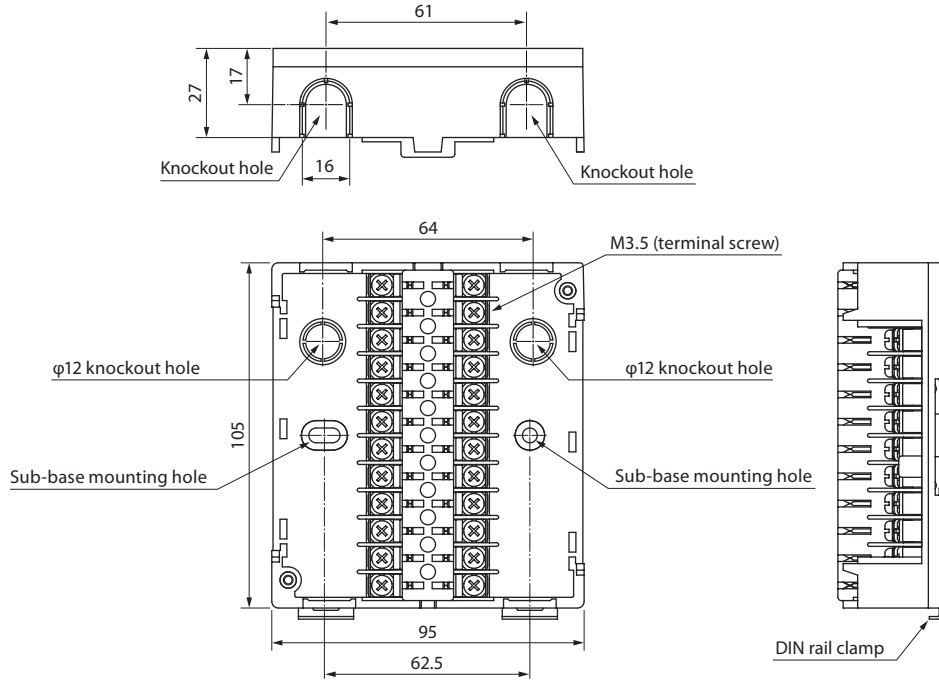

● Sideboard 81447515-001 (sold separately)

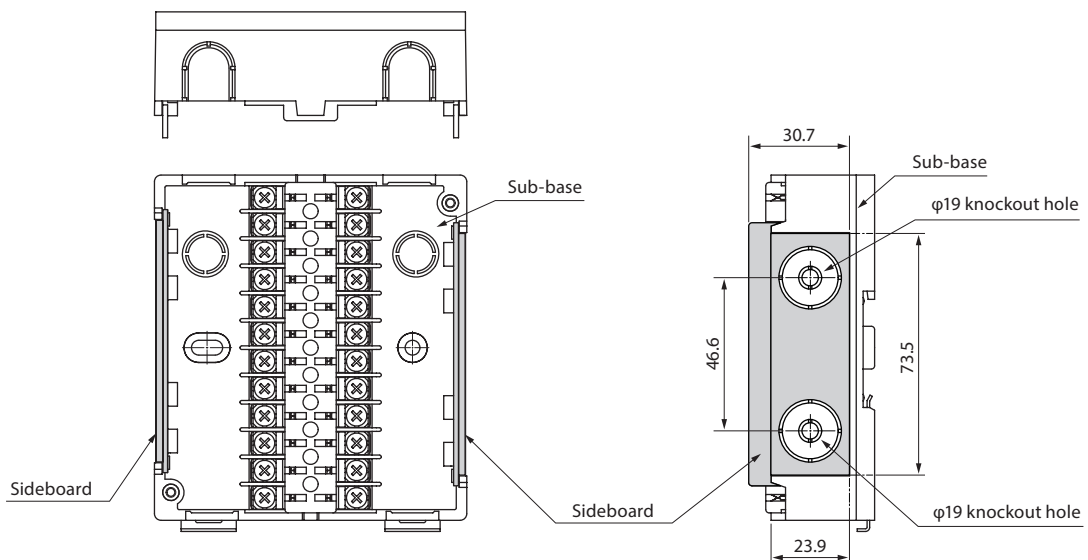

# Revision History of CP-SP-1388E

Printed	Edn.	Revised pages	Description
<b>Jan. 2015</b>	<b>1</b>		
<b>Jun. 2015</b>	<b>2</b>	ii, iii 4, 5 47, 48 47 48	Warnings and cautions were partly revised in the Safety Precautions section. Warnings and cautions were partly revised in Chapter 2. "*" was changed to "*1." "*2" was added to the end of "Monitor outputs." A note was added as *2.

# Terms and Conditions

We would like to express our appreciation for your purchase and use of Azbil Corporation's products. You are required to acknowledge and agree upon the following terms and conditions for your purchase of Azbil Corporation's products (system products, field instruments, control valves, and control products), unless otherwise stated in any separate document, including, without limitation, estimation sheets, written agreements, catalogs, specifications and instruction manuals.

## 1. Warranty period and warranty scope

### 1.1 Warranty period

Azbil Corporation's products shall be warranted for one (1) year from the date of your purchase of the said products or the delivery of the said products to a place designated by you.

### 1.2 Warranty scope

In the event that Azbil Corporation's product has any failure attributable to azbil during the aforementioned warranty period, Azbil Corporation shall, without charge, deliver a replacement for the said product to the place where you purchased, or repair the said product and deliver it to the aforementioned place.

Notwithstanding the foregoing, any failure falling under one of the following shall not be covered under this warranty:

- (1) Failure caused by your improper use of azbil product (noncompliance with conditions, environment of use, precautions, etc. set forth in catalogs, specifications, instruction manuals, etc.);
- (2) Failure caused for other reasons than Azbil Corporation's product;
- (3) Failure caused by any modification or repair made by any person other than Azbil Corporation or Azbil Corporation's subcontractors;
- (4) Failure caused by your use of Azbil Corporation's product in a manner not conforming to the intended usage of that product;
- (5) Failure that the state-of-the-art at the time of Azbil Corporation's shipment did not allow Azbil Corporation to predict; or
- (6) Failure that arose from any reason not attributable to Azbil Corporation, including, without limitation, acts of God, disasters, and actions taken by a third party.

Please note that the term "warranty" as used herein refers to equipment-only-warranty, and Azbil Corporation shall not be liable for any damages, including direct, indirect, special, incidental or consequential damages in connection with or arising out of Azbil Corporation's products.

## 2. Ascertainment of suitability

You are required to ascertain the suitability of Azbil Corporation's product in case of your use of the same with your machinery, equipment, etc. (hereinafter referred to as "Equipment") on your own responsibility, taking the following matters into consideration:

- (1) Regulations and standards or laws that your Equipment is to comply with.
- (2) Examples of application described in any documents provided by Azbil Corporation are for your reference purpose only, and you are required to check the functions and safety of your Equipment prior to your use.
- (3) Measures to be taken to secure the required level of the reliability and safety of your Equipment in your use  
Although azbil is constantly making efforts to improve the quality and reliability of Azbil Corporation's products, there exists a possibility that parts and machinery may break down.  
You are required to provide your Equipment with safety design such as fool-proof design, \*1 and fail-safe design\*2 (anti-flame propagation design, etc.), whereby preventing any occurrence of physical injuries, fires, significant damage, and so forth. Furthermore, fault avoidance, \*3 fault tolerance,\*4 or the like should be incorporated so that the said Equipment can satisfy the level of reliability and safety required for your use.

\*1. A design that is safe even if the user makes an error.

\*2. A design that is safe even if the device fails.

\*3. Avoidance of device failure by using highly reliable components, etc.

\*4. The use of redundancy.

## 3. Precautions and restrictions on application

Azbil Corporation's products other than those explicitly specified as applicable (e.g. azbil Limit Switch For Nuclear Energy) shall not be used in a nuclear energy controlled area (radiation controlled area).

Any Azbil Corporation's products shall not be used for/with medical equipment.

The products are for industrial use. Do not allow general consumers to install or use any Azbil Corporation's product.

However, azbil products can be incorporated into products used by general consumers. If you intend to use a product for that purpose, please contact one of our sales representatives.

In addition,

you are required to conduct a consultation with our sales representative and understand detail specifications, cautions for operation, and so forth by reference to catalogs, specifications, instruction manual, etc. in case that you intend to use azbil product for any purposes specified in (1) through (6) below.

Moreover, you are required to provide your Equipment with fool-proof design, fail-safe design, anti-flame propagation design, fault avoidance, fault tolerance, and other kinds of protection/safety circuit design on your own responsibility to ensure reliability and safety, whereby preventing problems caused by failure or nonconformity.

- (1) For use under such conditions or in such environments as not stated in technical documents, including catalogs, specification, and instruction manuals
- (2) For use of specific purposes, such as:
  - \* Nuclear energy/radiation related facilities  
[For use outside nuclear energy controlled areas] [For use of Azbil Corporation's Limit Switch For Nuclear Energy]
  - \* Machinery or equipment for space/sea bottom
  - \* Transportation equipment  
[Railway, aircraft, vessels, vehicle equipment, etc.]
  - \* Antidisaster/crime-prevention equipment

- \* Burning appliances
  - \* Electrothermal equipment
  - \* Amusement facilities
  - \* Facilities/applications associated directly with billing
- (3) Supply systems such as electricity/gas/water supply systems, large-scale communication systems, and traffic/air traffic control systems requiring high reliability
  - (4) Facilities that are to comply with regulations of governmental/public agencies or specific industries
  - (5) Machinery or equipment that may affect human lives, human bodies or properties
  - (6) Other machinery or equipment equivalent to those set forth in items (1) to (5) above which require high reliability and safety
4. Precautions against long-term use
 

Use of Azbil Corporation's products, including switches, which contain electronic components, over a prolonged period may degrade insulation or increase contact-resistance and may result in heat generation or any other similar problem causing such product or switch to develop safety hazards such as smoking, ignition, and electrification. Although acceleration of the above situation varies depending on the conditions or environment of use of the products, you are required not to use any Azbil Corporation's products for a period exceeding ten (10) years unless otherwise stated in specifications or instruction manuals.
  5. Recommendation for renewal
 

Mechanical components, such as relays and switches, used for Azbil Corporation's products will reach the end of their life due to wear by repetitious open/close operations. In addition, electronic components such as electrolytic capacitors will reach the end of their life due to aged deterioration based on the conditions or environment in which such electronic components are used. Although acceleration of the above situation varies depending on the conditions or environment of use, the number of open/close operations of relays, etc. as prescribed in specifications or instruction manuals, or depending on the design margin of your machine or equipment, you are required to renew any Azbil Corporation's products every 5 to 10 years unless otherwise specified in specifications or instruction manuals. System products, field instruments (sensors such as pressure/flow/level sensors, regulating valves, etc.) will reach the end of their life due to aged deterioration of parts. For those parts that will reach the end of their life due to aged deterioration, recommended replacement cycles are prescribed. You are required to replace parts based on such recommended replacement cycles.
  6. Other precautions
 

Prior to your use of Azbil Corporation's products, you are required to understand and comply with specifications (e.g., conditions and environment of use), precautions, warnings/cautions/notices as set forth in the technical documents prepared for individual Azbil Corporation's products, such as catalogs, specifications, and instruction manuals to ensure the quality, reliability, and safety of those products.
  7. Changes to specifications
 

Please note that the descriptions contained in any documents provided by azbil are subject to change without notice for improvement or for any other reason. For inquires or information on specifications as you may need to check, please contact our branch offices or sales offices, or your local sales agents.
  8. Discontinuance of the supply of products/parts
 

Please note that the production of any Azbil Corporation's product may be discontinued without notice. For repairable products, we will, in principle, undertake repairs for five (5) years after the discontinuance of those products. In some cases, however, we cannot undertake such repairs for reasons, such as the absence of repair parts. For system products, field instruments, we may not be able to undertake parts replacement for similar reasons.
  9. Scope of services
 

Prices of Azbil Corporation's products do not include any charges for services such as engineer dispatch service. Accordingly, a separate fee will be charged in any of the following cases:

    - (1) Installation, adjustment, guidance, and attendance at a test run
    - (2) Maintenance, inspection, adjustment, and repair
    - (3) Technical guidance and technical education
    - (4) Special test or special inspection of a product under the conditions specified by you

Please note that we cannot provide any services as set forth above in a nuclear energy controlled area (radiation controlled area) or at a place where the level of exposure to radiation is equivalent to that in a nuclear energy controlled area.

**azbil**

*Specifications are subject to change without notice.* (09)

---

**Azbil Corporation**  
Advanced Automation Company

1-12-2 Kawana, Fujisawa  
Kanagawa 251-8522 Japan

URL: <http://www.azbil.com>

1st edition: Jan. 2015 (K)  
2nd edition: Jun. 2015 (V)